

Star Trac Fitness™

E-TR Treadmill

OWNER'S MANUAL



expect different.

TABLE OF CONTENTS

Introduction	1
Chapter 1: Safety Instructions	2
Vieligheidsinstructies	3
Precautions	4
Mesures de Precaution	5
Sicherheitsvorschriften	6
Istruzioni di Sicurezza	7
Instruções de Segurança	8
Instrucciones de Seguridad	9
Sikkerhedsinstruktioner	10
Chapter 2: Assembly and Setup	11
Unpacking	11
Assembly	11
Chapter 3: Operating Instructions	17
Display Control Panel Features	17
Soft Trac® System	18
Hints and Tips for Getting Started	18
Quick Start	19
Preset Programs	19
Training Tools	22
Cool down Cycle	28
Calculation for VO2 Max	29
Using the Cooling Fan	30
Using the Weight Scale	30
Heart Rate Monitoring	30
Chapter 4: Exercise Tips and Training	31
The First Step to a Better Lifestyle	31
Getting Started - Walkers and Runners	31
Climbing the Conditioning Ladder - Suggested Programs	32
Program Variation on the E SERIES TREADMILL	33
Tips to Stay Motivated	34
Chapter 5: Preventative Maintenance	35
Daily Maintenance	35
Weekly Maintenance	35
Bi-Weekly Maintenance	35
Monthly Maintenance	35
Adjustments	36
Chapter 6: Settings and Testing	37
Manager Mode	37
Maintenance Mode	38
Speed Calibration	40
Elevation Calibration	41
Chapter 7: Troubleshooting	42
Chapter 8: Regulatory Information	43
FCC and Other Domestic / International Regulations	43
International Regulations	43

Copyright 2007. Star Trac by Unisen, Inc. All rights reserved, including those to reproduce this book or parts thereof in any form without first obtaining written permission from Star Trac.

Every effort has been made to keep this information current; however, periodically, changes are made to the information herein, and these changes will be incorporated into new editions of this publication. All product names and logos are trademarks of their respective owners. Printed in the USA.

INTRODUCTION

Welcome to the world of **STAR TRAC**. This Owner's Manual will acquaint you with the assembly, operation and maintenance of your **STAR TRAC E SERIES TREADMILL**, so that you may begin reaching your fitness goals.

The E SERIES TREADMILLS provide the most comprehensive integration of user needs with the Club's needs in the Club's most used cardiovascular product, the Treadmill. Users will appreciate the feel of the Soft Trac® system and the style and utility of the multifunctional E series display. With a iPod® rest, reading rack, and bottle holder stylishly integrated into the display, it is obvious that the design was generated with the user in mind. Further, the simplicity of these programmable treadmills understates their usability and feature-rich design.

We highly recommend that you read this owner's manual prior to setting up and using your treadmill. The information on the following pages will enable you to begin easily, quickly and safely.

WARNING

Your **STAR TRAC E SERIES TREADMILL** is designed for aerobic exercise in a gymnasium or health club environment.

Please check with your physician prior to beginning any exercise program.

Do not push yourself to excess. Stop if you are feeling faint, dizzy, or exhausted. Use common sense when walking or running on treadmill. Please read the owner's manual in its entirety before operating the treadmill.

IMPORTANT SAFETY INSTRUCTIONS

WARNING

This product will be wired for either 120 VAC nominal power input OR 230 VAC nominal input. It is factory-equipped with a specific electric cord and plug to permit connection to the proper electric circuit. Make sure that the product is connected to a dedicated power line having an outlet with the same configuration as that of the plug. NO adapter should be used with this product. If the product must be reconnected for use on a different type of electric circuit, the reconnection should be made by qualified service personnel. **Warning: If the supply cord is damaged, it must be replaced by the manufacturer, its service agent, or similarly qualified persons in order to avoid hazard.**

SAVE THESE INSTRUCTIONS

ATTENTION

Star Trac recommends that treadmills be spaced a minimum of 20.0 inches (0.5 m) apart to allow safe and easy ingress and egress. More importantly, there must be at least 48 inches (1.25 m) of free space behind the treadmills.

As with any motorized equipment, the area where treadmills are located must be free of obstructions and fixtures with sharp edges to prevent injury in the event that a user trips or loses balance and falls. DO NOT place treadmill near wet areas (such as pools, showers, etc.).

This chapter includes fitness safeguards and precautions for the installation and use of the E SERIES TREADMILL. These safety notes are directed to you as the owner of the Star Trac E SERIES TREADMILL. Please read this chapter carefully before installing or using your equipment and be sure to train all your members and fitness staff to follow these safety instructions.

Safety instructions are provided in the following languages (in the order shown):

- Dutch
- English
- French
- German
- Italian
- Portuguese
- Spanish
- Swedish

VEILIGHEIDSINSTRUCTIES

WAARSCHUWING

Dit produkt is voor gebruik op een circuit met een nominale waarde van 120 volt en is in de fabriek uitgerust met een speciaal elektrisch snoer en stekker om verbinding met een passend elektrisch circuit toe te staan. Zorg ervoor dat dit produkt verbonden is met een stopcontact dat dezelfde configuratie heeft als de stekker. **GEBRUIK GEEN ADAPTER BIJ DIT PRODUKT.** Als het produkt opnieuw verbonden moet worden met een ander type van elektrisch circuit, dan moet deze verbinding gemaakt worden door gekwalificeerd onderhoudspersoneel.



VOORZICHTIG: NEEM DE STEKKER UIT HET STOPCONTACT VOOR HET RENIGEN OF ONDERHOULD.



VOORZICHTIG: LEES HET INSTRUCTIEHANDBOEK VOORDAT U DE MACHINE BEDIENT.



VOORZICHTIG: BEWEGENDE ONDERDELEN. HOUD UW HANDEN EN VOETEN ONDER DE LOPENDE BAND VANDAAN.



STOPPEN (VAN ACTIE)



WISSELSTROOM

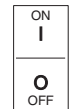

AAN

UIT

Deze veiligheidsinstructies zijn aan u gericht als de eigenaar van de **STAR TRAC E SERIES HARDLOOPBAND**. Train uw leden en fitness-personeel om deze veiligheidsinstructies te volgen.

LEES ALLE INSTRUCTIES VOORDAT U DE HARDLOOPBAND GEBRUIKT.

WAARSCHUWING: Om het risico van een elektrische schok te verminderen, dient u de stekker van de hardloopband **ALTIJD** uit het stopcontact te nemen voordat u hem schoonmaakt.

DOE DIT WEL

Stop de bediening van de hardloopband als u zich duizelig voelt of het gevoel heeft dat u flauwvalt.

Weet hoe ver u kunt gaan.

Zorg ervoor dat het oppervlak van de band schoon en droog blijft.

Neem de stekker uit het stopcontact voordat u de band reinigt of welk onderdeel dan ook verwijdt of vervangt. Gebruik dit product alleen voor het doeleinde waarvoor het bestemd is.

Zorg ervoor dat u weet waar de noodstop zit en hoe deze werkt.

Verricht regelmatig preventief onderhoud.

Houd het snoer bij verwarmingssystemen vandaan.

Wacht totdat de lopende band stil staat voordat u van de hardloopband stapt.

Houd luchtopeningen vrij van pluizen, haar etc. Bedien de hardloopband nooit met geblokkeerde luchtopeningen.

Schakel de stroom uit bij de contactschakelaar.

DOE DIT NIET

Laat kinderen niet zonder toezicht de hardloopband bedienen.

Zorg ervoor dat het maximaal toegestane gewicht (226 kg) niet wordt overschreden.

Ga de band niet op af terwijl deze loopt.

Niet buiten gebruiken.

Draag geen loszittende kleding als u de lopende band bedient.

Draai de lopende band niet te strak aan.

Bedien de hardloopband niet als deze een beschadigd snoer of stekker heeft, als hij niet goed werkt of als hij gevallen of beschadigd is. Neem contact op met uw geautoriseerde **STAR TRAC** detailhandelaar of de onderhoudsafdeling van **STAR TRAC** op +1 (714) 669-1660 of bezoek onze website op <http://www.startrac.com> voor een onmiddellijke inspectie of reparatie.

Gebruik de hardloopband niet zonder gymshoenen. Laat nooit objecten in het apparaat vallen en steek geen objecten, handen of voeten in welke opening van het apparaat dan ook of onder het apparaat.

Plaats geen waterflessen of bekers op uw hardloopband tenzij u een houder heeft die speciaal ontworpen is voor hardloopbanden. Gebruik uw hardloopband niet in een omgeving waar spuitbussen worden gebruikt of waar zuurstof wordt toegediend.

Bedien het apparaat niet zonder de motorafscherming of pas het apparaat op geen enkele wijze aan.

PRECAUTIONS



CAUTION: READ THE OWNER'S MANUAL COMPLETELY BEFORE OPERATING THIS TREADMILL



CAUTION: BEFORE CLEANING OR SERVICING, DISCONNECT POWER SUPPLY



CAUTION: MOVING PARTS, KEEP HANDS AND FEET FROM UNDER THE TREADMILL WHEN OPERATING



STOP (OF ACTION)



ALTERNATING CURRENT

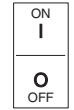

ON

OFF

These safety notes are directed to you as the owner of the **STAR TRAC E SERIES TREADMILL**. For safety purposes, please train all your members and fitness staff to follow these safety instructions.

DO

Do encourage your members to discuss their health program or fitness regimen with a health care professional, especially if they have not exercised for several years, are over 35, or have known health conditions.

Do read all instructions in this manual before using your treadmill.

Do use your treadmill only for its intended use, as described in this manual.

Do check to ensure the belt is not moving prior to using the treadmill.

Do keep the belt surface clean and dry.

Do stop operating your treadmill if you feel dizzy, faint or exhausted.

Do exercise slowly until you reach a level of comfort and security.

Do be aware of the location and proper use of the emergency STOP key.

Do perform regular preventive maintenance as suggested in the manual.

Do keep the electrical cord away from sources of excessive heat.

Do keep the treadmill air openings free of lint, hair, etc.

Do unplug your treadmill before doing any maintenance or cleaning.

Do warm up and cool down before and after each workout.

Do set your goals (see Getting Started in Chapter 6).

Do complement your walking, jogging, and running with a nutritious diet.

Do try charting your progress using the feedback from your treadmill.

Do try using the incline feature to burn more calories and strengthen your lower-body muscles.

DO NOT

Do not let children operate your treadmill. Supervise invalids or disabled persons who use your treadmill.

Do not exceed the maximum allowable weight limit (500 lbs. / 226 kg) for the treadmill.

Do not leave your treadmill unattended when it is plugged in. Unplug it from the outlet when it is not in use, and before you remove or replace any parts or accessories.

Do not use your treadmill without athletic shoes.

Do not wear loose or hanging clothing while using the treadmill.

Do not step or jump on or off your treadmill if the belt is moving.

Do not use or store your treadmill outdoors or in an enclosed pool environment.

Do not ever drop or insert any object, hands, or feet into any opening, or underneath this equipment.

Do not place water bottles or cups on your treadmill unless you are using the designed holders for the treadmill. Do not use your treadmill where aerosol (spray) products are being used or where oxygen is being administered.

Do not use attachments or parts not recommended by the manufacturer.

Do not run the equipment with the motor shroud removed, or modify the equipment in any way.

Do not overtighten the running belt.

Do not operate your treadmill if it has a damaged cord or plug, if it is not working properly, if it has been dropped or damaged, or if the display shows an error code. Call your dealer or Star Trac at (800) 503-1221, or USA 1-714-669-1660 for service.

MESURES DE PRECAUTION



ATTENTION: LISEZ SOIGNEUSEMENT LE MANUEL D'UTILISATION AVANT D'UTILISER CE TAPIS ROULANT



ATTENTION: DÉBRANCHEZ A LA SOURCE AVANT D'EFFCTUER UN ENTRETIEN DU UNE RÉPARATION



ATTENTION: : CONTIENT DES PIECES MOBILES. GARDEZ LES MAINS ET LES PIEDS A L'ECART DE LA PARTIE INFÉRIEURE DU TAPIS ROULANT PENDANT SON FONCTIONNEMENT.



ARRÊT (MISE HORS SERVICE)



COURANT ALTERNATIF

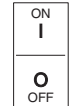

OUVRE

FERME

Ces instructions sont destinées au propriétaire du **TAPIS STAR TRAC E SERIES**. Assurez vous que votre personnel et vos adhérents les suivent toujours.

Encouragez vos adhérents à parler de leur programme d'entraînement à un médecin ou un entraîneur, en particulier s'ils n'ont pas eu d'activité sportive pendant plusieurs années, s'ils ont plus de 35 ans ou s'ils ont des kilos superflus.

Lisez le manuel avant faire fonctionner le tapis.

Utilisez le tapis exclusivement aux fins don't il est destiné. N'utilisez pas d'accessoires qui n'ont pas été recommandés par le fabricant.

Attachez toujours vos lacets et vêtements quand vous courez sur le tapis.

Conserver la surface du tapis propre et sèche.

Arrêtez si vous êtes pris de vertiges ou épuisé.

Commencez toujours à une vitesse lente.

Respectez les périodes d'échauffement et de récupération.

Vérifier où se trouve l'interrupteur STOP d'urgence et comment l'utiliser correctement.

Entrez vos objectifs (voir chapitre 6).

Complétez votre entraînement par un régime alimentaire.

Suivez votre progrès grâce aux informations du tableau de bord.

Essayez d'utiliser l'inclinaison afin de brûler plus de calories et de renforcer les muscles de membres inférieurs.

Effectuez régulièrement l'entretien préventif du tapis.

Mettez les fils électriques à l'abri de chaleur.

Enlevez poussière, cheveux etc. de l'aération.

Ne laissez pas d'enfants non-accompagnés sur le tapis. Une surveillance très stricte est nécessaire si des personnes invalides ou handicapées utilisent le tapis.

Ne pas dépasser la charge maximum (226 kg) admise pour le tapis roulant.

Ne laissez jamais le tapis sans surveillance s'il est branché. Débranchez le tapis si vous ne l'utilisez pas ou avant de monter ou démonter des pièces.

Ne pas porter de vêtements larges ou pendants lors de l'utilisation du tapis roulant.

Utilisez le tapis uniquement avec des chaussures appropriées.

Ne descendez pas ou ne montez pas sur un tapis qui est en fonction.

N'utilisez ou ne stockez jamais le tapis à l'extérieur ou près d'une piscine.

Ne laissez rien rentrer dans les ouvertures. Ne posez pas vos pieds sous l'appareil.

Ne posez pas de bouteilles ou verres d'eau sur l'appareil sans être équipé avec le () en option.

N'utilisez pas le tapis dans les endroits où des aérosols ou de l'oxygène ont été utilisés.

Débranchez le tapis avant le nettoyage ou le changement de fusibles.

N'enlevez pas de vis, ne modifiez pas l'appareil.

Ne serrez pas trop fort la surface caoutchoutée.

N'utilisez pas cet appareil si les fils ou la fiche sont endommagés, s'il est tombé ou cassé. Appelez votre distributeur pour une révision ou réparation.

SICHERHEITSVORSCHRIFTEN

WARNUNG

Dieses Produkt ist für den Gebrauch an einer passenden Netzsteckdose mit 220 Volt Spannung bestimmt und werkseitig mit einer dafür vorgesehenen Netzleitung und einem Netzstecker ausgerüstet. Stellen Sie sicher, daß das Gerät nur an einem Anschluß mit gleicher Bauart wie der Stecker angeschlossen wird. VERWENDEN SIE DEINEN ADAPTER FÜR DEN BETRIEB DES PRO / PRO S. Wenn das Gerät zum Betrieb an einem anderen Stromnetz auf einen anderen Netzstecker umgerüstet werden muß, sollte die Umrüstung durch einen qualifizierten Elektriker durchgeführt werden.



ACHTUNG: GERÄT VOR DEM REINIGEN ODER WARTEN VON DER STROMVERSORGUNG TRENNEN

Diese



BEDIENUNG UNTERBRECHEN



ACHTUNG: VOR DER BENUTZUNG SICHERHEITSVORSCHRIFTEN LESEN



WECHSELSTROM



VORSICHT: BEWEGLICHE TEILE - BEI BETRIEB HÄNDE UND FÜSSE VOM BEREICH UNTERHALB DES LAUFBANDES FERN HALTEN

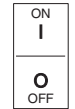

EIN

AUS

Sicherheitshinweise sind an Sie, den Besitzer des Laufbandes **STAR TRAC E SERIES**, gerichtet. Bitte weisen Sie Ihre Mitglieder und Ihre Fitneß-Mitarbeiter an, sich an die folgenden Sicherheitsvorschriften zu halten.

LESEN SIE ALLE ANWEISUNGEN VOR DER BENUTZUNG DEL LAUFBANDES.

WARNUNG: Um das Risiko eines elektrischen Schlages zu vermeiden, nehmen Sie den Stecker des Laufbands vor dem Reinigen **IMMER** aus der Netzsteckdose.

SIE SOLLTEN...

Die Benutzung des Laufbandes beenden, wenn Schwindel oder Benommenheit auftritt.

Au Ihre Grenzen denken.

Das Laufband vor jeglichen Wartungsund Reinigungsarbeiten abschalten.

Das Gerät nur für den vorgesehenen Verwendungszweck benutzen.

Halten Sie die Oberfläche des Bandes sauber und trocken.

Informieren Sie sich über den Ort und die korrekte Verwendung des Stoppschalters für den Notfall.

Regelmäßige vorbeugende Wartungsarbeiten durchführen.

Die elektrischen Leitungen von Wärmequellen fernhalten.

Den Stillstand des Laufriemens abwarten, bevor Sie das Laufband auseinanderbauen.

Die Lüftungsöffnungen frei von Staub, Haaren und Ähnlichem halten.

Das Laufband niemals mit verdeckten Lüftungsschlitzen betreiben.

Die Stromversorgung immer am Netzschalter abschalten.

SIE SOLLTEN NIEMALS...

Kinder das Laufband unbeaufsichtigt benutzen lassen.

Achten Sie darauf, die Höchstgewichtsgrenze (226 kg) für das Laufband nicht zu überschreiten.

Schutzvorrichtungen entfernen oder das Gerät umbauen.

Tragen Sie keine lockere oder herabhängende Kleidung, wenn Sie das Laufband benutzen.

Das Gerät im Freien benutzen.

Den Laufriemen überspannen.

Das Laufband mit beschädigter Netzleitung betreiben, wenn es nicht richtig funktioniert, heruntergefallen ist oder beschädigt wurde. Für sofortige Reparaturunterstützung kontaktieren Sie einen autorisierten Händler oder den Kundendienst von **STAR TRAC** telefonisch unter +1 714 669 1660, bzw. Benutzen Sie unsere Web-Seite unter <http://www.startrac.com>.

Das Laufband ohne die passenden Sportschuhe benutzen.

Gegenstände in eine Öffnung am Gerät hineinfallen lassen.

Gegenstände, Hände oder Füße in eine Öffnung am Gerät stecken oder diese unter das Gerät legen.

Wasserflaschen oder Trinkbecher auf das Laufband stellen, es sei denn, Sie haben ein speziell für diesen Zweck und für dieses Laufband gedachtes Zubehörteil.

Das Laufband in Räumlichkeiten benutzen, in denen Produkte in Aerosoldosen (Sprays) angewandt werden oder in denen Sauerstoff verabreicht wird.

Das Laufband mit abgenommener Motorabdeckung laufen lassen, oder das Gerät auf irgendeine Art und Weise verändern.

ISTRUZIONI DI SICUREZZA

ATTENZIONE

Questo prodotto è da usare su un circuito elettrico con una tensione nominale di 220 volt ed è fornito dalla fabbrica con un cavo elettrico e spina specifici per permettere il collegamento ad un circuito elettrico appropriato. Assicuratevi che il prodotto sia collegato ad una presa che abbia la stessa configurazione della spina. **NESSUN ADATTATORE DEVE ESSERE USATO CON QUESTO PRODOTTO.** Se il prodotto deve essere ricollegato per l'uso su un circuito elettrico diverso, il ricollegamento deve essere effettuato da un elettricista qualificato.



ATTENZIONE: PRIMA DI PULIRE O ESEGUIRE LA MANUTENZIONE, TOGLIETE LA SPINA



ATTENZIONE: PRIMA DI USARE LEGGETE IL MANUALE DELLE ISTRUZIONI



ATTENZIONE: PARTI IN MOVIMENTO. DURANTE IL FUNZIONAMENTO DEL TREADMILL ALLONTARE MANI E PIEDI DAL SUO RAGGIO D'AZIONE



FERMA IL MOVIMENTO



CORRENTE ALTERNATA



ACCESO

SPENTO

Queste indicazioni sono indirizzate ai proprietari del **TREADMILL STAR TRAC E SERIES**. Chiedete a tutti i membri della vostra palestra e al vostro staff di seguire queste istruzioni di sicurezza.

LEGGETE TUTTE LE ISTRUZIONI PRIMA DI USARE IL TREADMILL.

ATTENZIONE: per ridurre il rischio di scossa elettrica, staccate **SEMPRE** la spina della corrente del treadmill prima di pulirlo.

DA FARE

Fermate il treadmill se vi sentite svenire o avete capogiri.

Siate coscienti dei vostri limiti.

Mantenere il nastro asciutto e pulito.

Staccate la spina prima di pulire, spostare o cambiare qualsiasi parte del treadmill.

Usate questo prodotto solo per l'uso inteso.

Assicurarsi di essere a conoscenza della posizione e dell'uso corretto del pulsante di emergenza STOP.

Eseguite la manutenzione regolare.

Mantenete la corda elettrica lontana da fonti di calore.

Aspettate fino a quando il nastro è completamente fermo prima di scendere dal treadmill.

Pulite le prese d'aria da polvere, capelli e simili. Non usate mai il treadmill con le prese d'aria bloccate.

Spegnete la macchina tramite l'interruttore.

DA NON FARE

Non permettete a bambini di usare il treadmill senza sorveglianza.

Non superare il peso limite massimo consentito (226 kg) per il treadmill.

Non salite o scendete dal treadmill mentre è in funzione.

Non usatelo all'aperto.

Durante l'uso del treadmill non indossare indumenti che possano impigliarsi in organi in movimento.

Non tirate troppo il nastro.

Non usate il treadmill se il cavo elettrico o la spina sono danneggiati, se non funziona come dovrebbe o se è caduto o è danneggiato. Contattate il vostro rivenditore autorizzato **STAR TRAC** o l'assistenza clienti dello **STAR TRAC** al numero +1 714 669 1660 o visitate il nostro sito Internet a <http://www.startrac.com>, per esame o riparazione immediata.

Usate il treadmill solo se calzate scarpe da ginnastica.

Non lasciate cadere oggetti e non inserite mani o piedi nelle aperture o al di sotto del treadmill.

Non appoggiate bottiglie d'acqua o bicchieri sul treadmill a meno che non stiate usando un supporto progettato appositamente per il treadmill.

Non usate il treadmill in posti dove sono usati prodotti aerosol (spray) o dove è somministrato dell'ossigeno.

Non accendete il treadmill con il coperchio del motore rimosso, e non modificalo in nessun modo.

INSTRUÇÕES DE SEGURANÇA

ADVERTÊNCIA

Este produto deve ser usado em um circuito com tensão nominal de 220 volts. Ele foi fabricado com um cabo de alimentação e plugue específicos para permitir a sua conexão com um circuito elétrico apropriado. Certifique-se de que o produto esteja conectado a uma tomada com as mesmas configurações do plugue. **NÃO UTILIZE ADAPTADORES PARA ESTE PRODUTO.** Se for necessário reconectar a produto para utilização em um tipo diferente de circuito elétrico, este procedimento deverá ser executado por pessoal qualificado.



ATENÇÃO: ANTES DE LIMPAR OU FAZER MANUTENÇÃO, DESCONECTE O APARELHO DA TOMA DA



ATENÇÃO: LEIA O MANUAL DE INSTRUÇÕES ANTES DE OPERAR A ESTEIRA



CUIDADO: PROTEJA AS MÃOS E OS PÉS AO MOVER PEÇAS COM A ESTEIRA EM FUNCIONAMENTO.



PARE (AÇÃO)



CORRENTE ALTERNADA

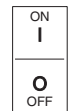

I LIGAR

O DESLIGAR

Estas observações de segurança destinam-se à você, proprietário de **ESTEIRA STAR TRAC E SERIES**. Treine todos os membros e funcionários que utilizarão o equipamento para que sigam estas instruções de segurança.

LEIA TODAS AS INSTRUÇÕES ANTES DE USAR SUA ESTEIRA

ADVERTÊNCIA: para reduzir os rescos de choque elétrico, **SEMPRE** desconecte a esteira da tomada antes de limpá-la

Pare de usar a esteira se você se sentir fraco ou com tontura.

Conserve a superfície da correia limpa e seca.

Reconheça seus limites.

Desconecte a esteira da tomada antes de limpá-la ou antes de remover ou substituir qualquer peça.

Utilize este equipamento única e exclusivamente para o seu devido fim.

Informe-se sobre a posição e o uso adequado da chave de emergência STOP.

Faça manutenção preventiva regularmente.

Mantenha o fio afastado de superfícies aquecidas.

Espere até que a esteira esteja completamente parada antes de descer do aparelho.

Mantenha as saídas de ar desobstruídas de fiapos de tecidos, cabelos e outros objetos. Nunca opere a esteira com as saídas de ar bloqueadas.

Desligue o aparelho com o interruptor de força.

Não permita que crianças operem a esteira sem supervisão de um adulto.

Não ultrapasse o limite de peso máximo permitido (226 kg) especificado na esteira.

Não suba ou desça da esteira enquanto ela estiver em movimento.

Não use roupas folgadas enquanto estiver utilizando a esteira.

Não utilize a esteira ao ar livre.

Não estique demais o tapete da esteira.

Não opere esta esteira se o cabo de alimentação ou o plugue da tomada estiverem danificados, se ela não estiver funcionando perfeitamente ou se tiver sofrido queda ou danos. Procure seu revendedor autorizado **STAR TRAC** ou o departamento de assistência técnica **STAR TRAC** pelo telefone 1 714 669 1660 ou acesse nosso "web site" no endereço <http://www.startrac.com> para fazer uma consulta ou conserto imediato.

Não utilize a esteira sem calçar tênis.

Não deixe cair nem introduza nenhum objeto, as mãos ou pés em nenhuma abertura do equipamento ou debaixo deste.

Não coloque garrafas d'água nem copos na esteira se não estiver utilizando o devido acessório projetado para esse fim. Não utilize a esteira onde estejam sendo usados produtos de aerosol (spray) ou em lugares onde esteja sendo administrado oxigênio. Não opere o equipamento com a tampa do motor removida nem faça nenhuma modificação no equipamento.

INSTRUCCIONES DE SEGURIDAD

ADVERTENCIA

Este producto está preparado para utilizarse en un circuito de 220 voltios y se suministra equipado de fábrica con un cable y un enchufe eléctricos específicos para permitir su conexión a un circuito eléctrico apropiado. Asegúrese de que el producto se conecte a una toma de corriente con la misma configuración que el enchufe. **NO UTILICE NINGÚN ADAPTADOR CON ESTE PRODUCTO.** Si este producto necesita ser modificado eléctricamente para utilizarse en un tipo diferente de circuito eléctrico, dicha modificación debe ser realizada únicamente por el personal de servicio calificado.



ATENCIÓN: DESCONECTE EL SUMINISTRO DE CORRIENTE ANTES DE LIMPIAR O REPARAR



ATENCIÓN: LEA EL MANUAL DE INSTRUCCIONES ANTES DE SU UTILIZACIÓN



ATENCIÓN: PIEZAS EN MOVIMIENTO! MANTENGA LAS MANOS Y LOS PIES ALEJADOS DE LA PARTE INFERIOR DE LA CINTA CUANDO LA MISMA ESTÉ EN FUNCIONAMIENTO



PARAR (EL FUNCIONAMIENTO)



CORRIENTE ALTERNA

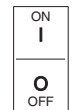

ENCENDIDO

APAGADO

Estas notas sobre seguridad van dirigidas a Vd. Como propietario del **TAPIZ RODANTE STAR TRAC E SERIES**. Haga que todos los usuarios y preparadores físicos cumplan estas instrucciones de seguridad.

LEA TODAS LAS INSTRUCCIONES ANTES DE UTILIZAR SU TAPIZ RODANTE.

ADVERTENCIA: Para reducir los riesgos de sufrir una descarga eléctrica, desenchufe **SIEMPRE** el tapiz rodante antes de limpiarlo.

QUÉ HACER

Detenga el tapiz rodante si se nota desfallecido o mareado.

Mantenga la superficie de la cinta seca y limpia.

Conozca sus limitaciones.

Desenchufe el tapiz rodante antes de limpiar, quitar o cambiar alguna pieza.

Asegúrese de saber dónde está el interruptor de emergencia STOP y cómo utilizarlo adecuadamente.

Utilice este producto sólo para los usos que está diseñado.

Realice un mantenimiento preventivo de manera regular.

Mantenga el cable separado de fuentes de calor.

Espere a que la cinta móvil haya parado antes de descender del tapiz rodante.

Mantenga las entradas de aire libres de pelusa, pelo y similares. No utilice nunca el tapiz rodante con las entradas de aire bloqueadas.

Desconecte de la corriente por medio del disyuntor.

QUÉ NO HACER

No permita que los niños utilicen el tapiz rodante sin supervisión.

No sobrepase el peso máximo permitido (226 kg) para la cinta andadora.

No suba o baje del tapiz rodante mientras está funcionando.

No lleve ropa suelta ni que cuelgue mientras utiliza la cinta andadora.

No debe utilizarse en exteriores.

No tense demasiado la cinta móvil.

No utilice este tapiz rodante si tiene el cable o el enchufe dañados, si no funciona adecuadamente o si ha sufrido algún golpe o deterioro. Póngase en contacto con su vendedor autorizado de **STAR TRAC**, con el departamento de servicios de **STAR TRAC** llamando al número +1 714 669 1660 o accediendo a nuestra página de la web en <http://www.startrac.com>, para un examen o reparación inmediatos.

No utilice el tapiz rodante sin calzado deportivo.

No deje caer ni introduzca ningún objeto, manos o pies en ninguna abertura del aparato o debajo del mismo.

No deje botellas de agua ni tazas sobre su tapiz rodante excepto si utiliza el accesorio adicional diseñado para este fin. No utilice su tapiz rodante en lugares en los que se están usando productos aerosoles (en spray) o en los que se está administrando oxígeno.

No encienda este aparato con la cubierta del motor retirada, ni lo modifique de ninguna manera.

SIKKERHEDSINSTRUKTIONER

ADVARSEL

Dette produkt er beregnet til brug i forbindelse med et el-net med nominel effekt på 220 volt. Det leveres med særlig ledning og stik fra fabrikken, som kun passer til den korrekte type el-net. Sørg for, at produktet er sat til en stikkontakt, som har samme konfiguration som stikket. DER MÅ IKKE BRUGES ADAPTER TIL DETTE PRODUKT. Hvis produktet absolut skal omstilles til en anden slags el-net, skal omstillingen foretages af kvalificeret servicepersonale.



FORSIGTIG: AFBRYD EL-KABLET, FØR DU GØR RENT ELLER SERVICERER.



FORSIGTIG: LÆS INSTRUKTIONSHÅNDBOGEN FØR BRUG



FORSIGTIG: RÖRLIGA DELAR - LÅT INGA HÄNDER ELLER FÖTTER BEFINNA SIG UNDER LÖPBANDET NÄR DET ÄR IGÅNG



STOP (AF FUNKTION)



VEKSELSTRØM

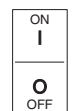

TÆND

SLUK

Disse sikkerhedsbemærkninger henvendes til ejeren af STAR TRAC E SERIES-TRÆDEMØLLEN. Sørg venligst for, at alle medlemmer og alt kondipersonale kender og følger disse sikkerhedsregler.

LÆS ALLE INSTRUKTIONERNE, FØR DU BRUGER DIN TRÆDEMØLLE.

ADVARSEL: For at mindske risikoen for at få elektrisk stød, skal du ALTID trække trædemøllens stik ud af kontakten, før du gør den ren.

SKAL

Stig af trædemøllen, hvis du bliver mat i kroppen eller svimmel.

Kend dine begrænsninger.

Håll löpbandets yta torr och ren.

Træk trædemøllens stik ud af kontakten, før du gør den ren, eller fjerner eller udskifter en del.

Brug kun produktet til det formål, det er beregnet til.

Foretag forebyggende vedligeholdelse med regelmæssige mellemrum.

Tänk på placeringen av löpbandet samt att du endast använder nödknappen STOP när det är nödvändigt.

Holdledningen fri af varme anlæg.

Vent til løbebåndet standser, før du stiger af trædemøllen.

Hold ventilationsåbningerne fri for fnug, hår og lignende. Brug aldrig trædemøllen med blokerede luftventilationsåbninger.

Sluk for elektriciteten på afbryderkontakten.

MÅ IKKE

Tillad ikke børn uden opsyn at bruge trædemøllen.

Överstig inte maximalt tillåtna vikt (226 kg) för löpbandet.

Stig ikke på eller af trædemøllen, mens den kører.

Bär inga löst hängande kläder som kan fastna när du använder löpbandet.

Brug ikke trædemøllen udendørs.

Stram ikke løbebåndet for meget.

Brug ikke trædemøllen, hvis ledningen eller stikket er beskadiget, hvis trædemøllen ikke fungerer rigtigt, eller hvis den er faldet ned eller væltet og er blevet beskadiget. Kontakt den autoreserede **STAR TRAC**, forhandler eller serviceafdelingen hos **STAR TRAC** Ring på +1 71 46 69 1660 eller du kan få fat i os på vores web-site: <http://www.startrac.com> for øjeblikkeligt eftersyn eller reparation.

Brug ikke trædemøllen uden kondisko.

Undgå at tabe eller at stikke genstande, hænder eller fødder ind i en åbning i eller under udstyret.

Stil ikke vandflasker eller kopper på trædemøllen, medmindre du har dertil beregnet tilbehør, som er specielt designet til trædemøllen. Brug ikke trædemøllen på steder, hvor der bruges aerosolprodukter (spray), eller hvor der administreres ilt.

Udstyret må ikke køre uden motorafskærmning, og det er ikke tilladt at ændre udstyret på nogen måde.

UNPACKING

Remove all parts from the shipping crate and verify that the following parts were included in your shipment:

Description	Qty.
Frame Assembly w/ Motor Shroud	1
Top Rail with Display	1
Neck	1
Side Rail w/ STOP Switch	1
Side Rail	1
Button, Plastic**	4
Screw, Button Head Socket Cap, 1/4"-28 UNC x 3/8"***	4
Screw, Socket Head Cap, 5/16"-18 UNC x 1.0"*	4
Bolt, Hex-head, 5/16"-18 UNC x 3.0"***	2
Washer, Flat, 5/16" I.D. x 1.5" O.D.**	2
Washer, Flat, 5/16" I.D. x 1.2" O.D.**	6
Washer, Split Lock, 5/16"***	6
Screw, 5/16"-18 x 7.5"***	2
Hex (Allen) key, 1/4"***	1
Hex (Allen) key, 5/32"***	1
Screwdriver, Phillips, #2**	1
Screwdriver (blade-tip), 3/32"***	1
Multi-End Wrench**	1
Owner's Manual with Warranty Registration Card	1

*Pre-inserted into frame assembly

Part of included **STAR TRAC tool kit.

Should any component not be present or if you have any operational questions, please call Star Trac's Service department at (800) 503-1221 or USA 1-714-669-1660. Specifically refer to your treadmill serial number and model number listed below:

Serial No. _____

Model No. _____

NOTE: The following assembly procedure applies to the E SERIES Treadmills.

ASSEMBLY

The following tools are required for assembly: Hex (Allen) Key, 1/4"; Hex (Allen) Key, 5/32"; Screwdriver, Phillips; Wrench, 1/2" (not provided). To assemble your **STAR TRAC E SERIES TREADMILL**, just follow these steps.

NOTE: Don't fully tighten bolts and screws until all parts are assembled.

1. Unpacking and Positioning the Frame Assembly

Remove all the packaging material so the treadmill is sitting, ready for assembly, on the shipping crate platform. With a helper, lift the treadmill frame assembly from the shipping crate platform and place it in the location where it will be used. Make sure the unit is placed near a power outlet.

Caution: The motor shroud end of the frame assembly is very heavy. Two people may be needed to lift this end when moving the frame assembly.

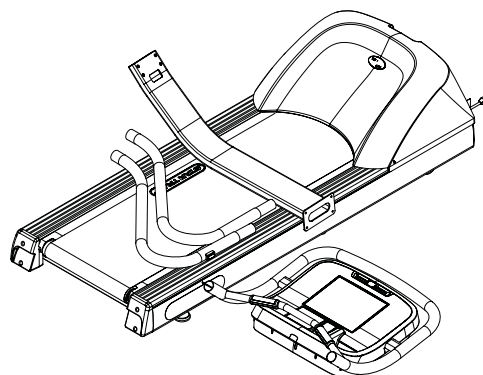

2. Installing the Neck

Remove the (4) pre-installed Socket Head Cap Screws and washers from the motor shroud end of the frame assembly. Retain the screws for use when installing the neck.

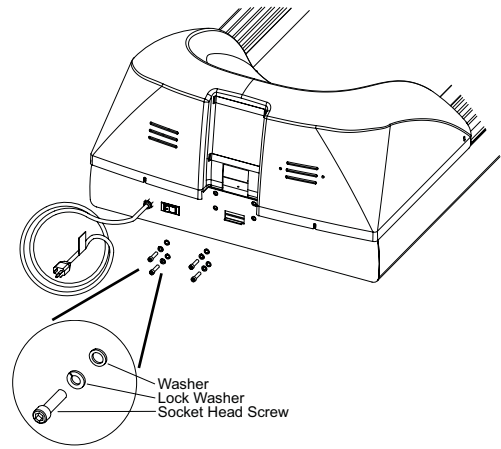

3. Removing the Motor Shroud

Remove the (4) 10-24 screws securing the motor shroud to the frame assembly, and lift the motor shroud off of the frame assembly. Retain the screws for use when re-installing the motor shroud.

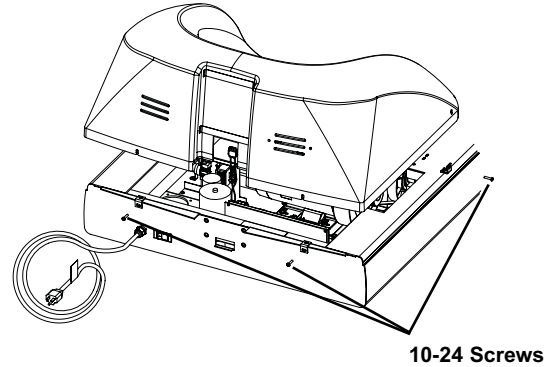

4. Installing the Neck

Position the bottom of the neck over the 4 threaded hole in the lower frame, and then use the 1/4" Hex Allen Key to install the (4) Socket Head Cap Screws and washers you removed earlier.

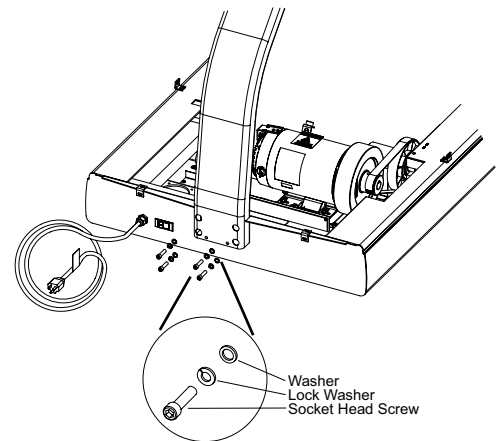

5. Installing the Display

a) Use the #2 Phillips Screwdriver to remove the (4) screws that hold the back of the shroud to the display unit. Retain screws for later use. Place the back shroud aside to be installed later. Be careful not to damage the plastic.

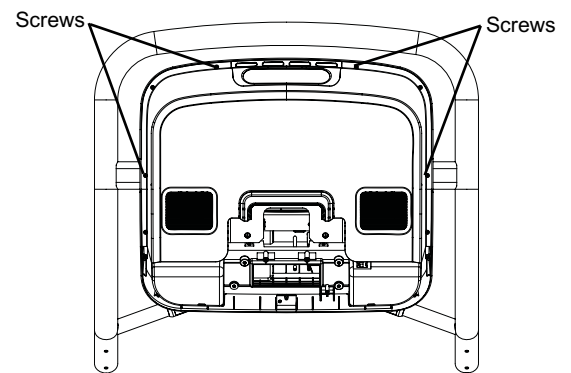

Step 5a

b) Lift the Display unit and take the (3) cables that are attached to the display and feed them down the neck (this may require 2 people). Use the 1/4" Hex allen key to install the (4) Socket Head Cap Screws through the mount into the display unit. Be careful not to pinch the cables.

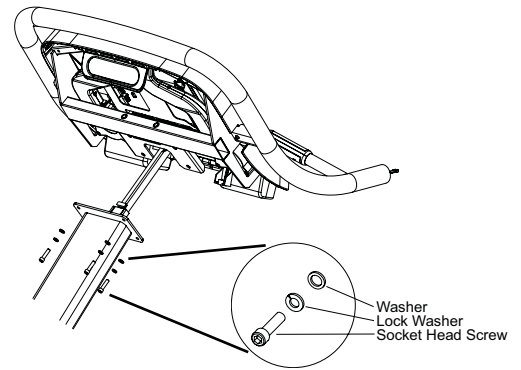

Step 5b

6. Installing the Handrails

a) Locate the left handrail (the handrail with the STOP switch). Connect the STOP switch cable from the handrail to the display cable extending from the display handrail stub.

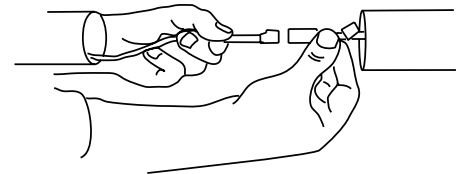

Step 6a

b) Insert the handrail connecting tube into the display handrail stub, taking care not to pinch the STOP switch cable between the handrail pieces. Make sure the handrail sits flush against the display handrail stub.

Rotate the handrail, if necessary, to align the drilled hole in the display handrail stub with the threaded hole in the handrail connecting tube. Secure the handrail to the display handrail stub using two 1/4"-28 x 3/8" screws.

Install the right handrail in a similar manner, omitting instructions related to the STOP switch cable.

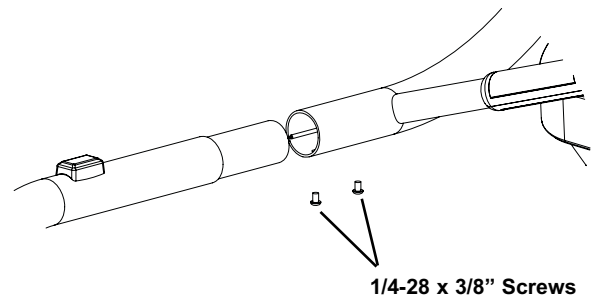

Step 6b

c) Insert the 5/16-18 x 7" Hex Head Bolt and washers through the bottom of the frame into the handrail. Use a 1/2" wrench to tighten the screws. Repeat for other side.

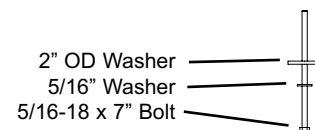
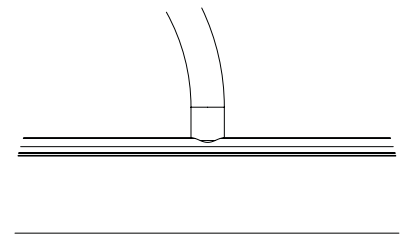

Step 6c

Once the display has been secured in place, route the display cables through the cutout in the bottom of the neck, and into the motor compartment.

6. Connecting the Display Cables

Locate the Motor Control Board (MCB) and the DC Power Board.

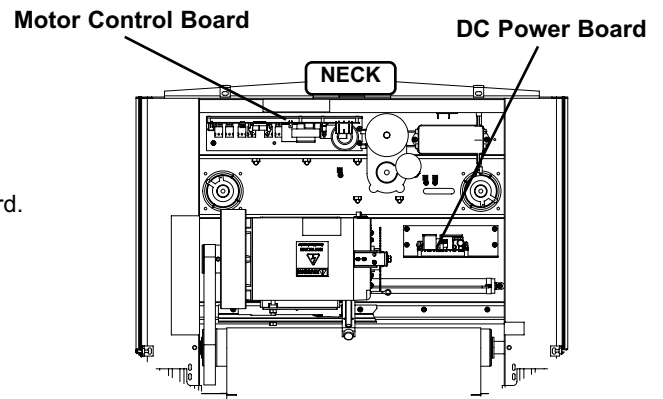

Take the cables from the lower neck service hole. Use the cable labeled MCB Cable and connect it to the MCB.

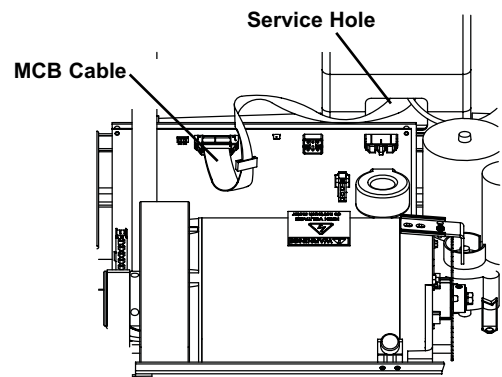

Now take the FAN Power cable from the neck and connect it to the DC Power board.

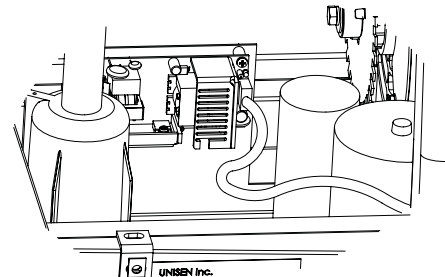

Go to the bottom of the display neck, Take the C-SAFE connector bracket and connect it to the neck using (2) M4 x 0.7 Phillips Head Screws.

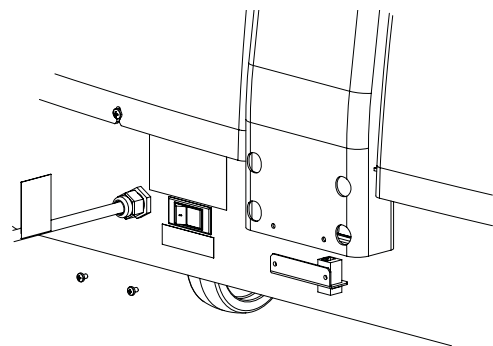

7. Final Assembly

Re-install the shroud over the motor compartment, install the (4) 10-24 Machine Screws that were saved from earlier. Insert the (4) plastic caps in the lower neck.

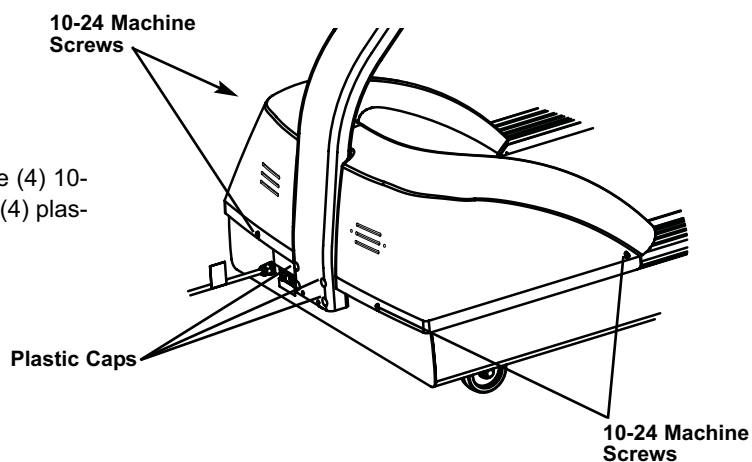

Install the bottom of the display using the (6) M4 x0.7 x 19mm long Phillips head screws. Next install the back of the display with (8) of the same screws.

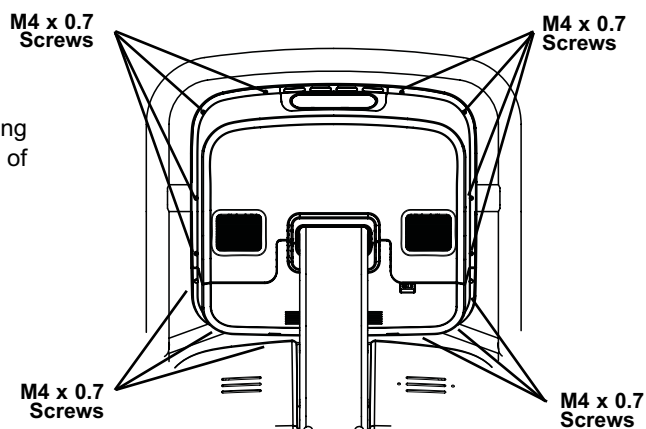

Securely tighten all hardware installed during assembly.

NOTE: Perform a visual inspection, and test the features and functions of the unit, prior to use.

You have now completed the assembly of your **STAR TRAC E SERIES TREADMILL**.

Leveling your E Series Treadmill

Before you plug in the treadmill, make sure it is where you plan to use it and it is level to the ground. If necessary, level your treadmill using the two adjustable feet under the tailroller. Loosen the lock nuts, rotate the feet until the treadmill is stabilized, and retighten the lock nuts.

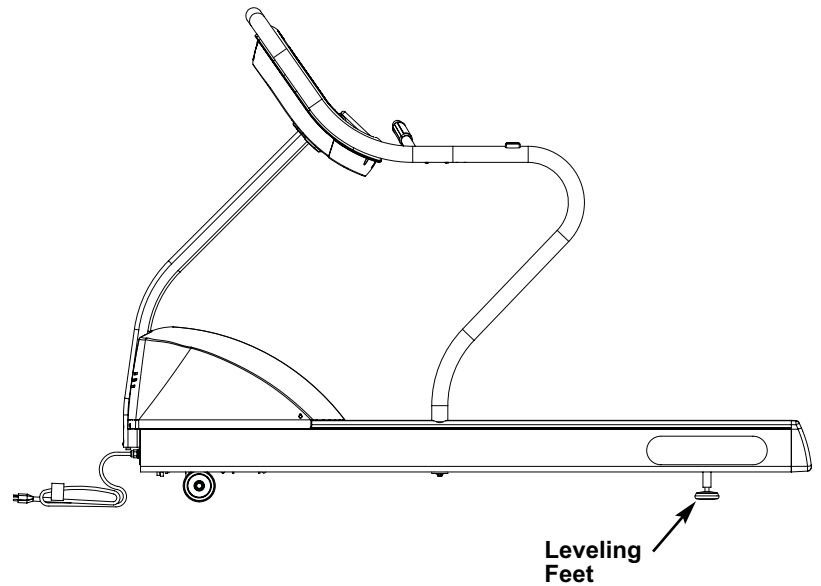

ATTENTION

Star Trac recommends that treadmills be spaced a minimum of 20.0 inches (0.5 m) apart to allow safe and easy ingress and egress. Even more importantly, there must be at least 48 inches (1.25 m) of free space behind the treadmills.

As with any motorized equipment, the area where treadmills are located must be free of obstructions and fixtures with sharp edges to prevent injury in the event that a user trips or loses balance and falls.

Operating the **STAR TRAC E SERIES TREADMILL** is very easy. Simply step onto the running belt, press QUICK START, and begin walking or running naturally.

Learning the features and incorporating the **STAR TRAC E SERIES TREADMILL** into your members' fitness programs is just as easy. In this chapter, you will learn the display function and how to get the most out of every **STAR TRAC E SERIES TREADMILL** workout.

IMPORTANT: Before operating the treadmill, you must be familiar with the following equipment limitations and safety features.

- **Maximum Weight:** Your STAR TRAC E SERIES Treadmill is designed for a maximum user weight of 500 lbs/226 kg. DO NOT exceed the maximum user weight.

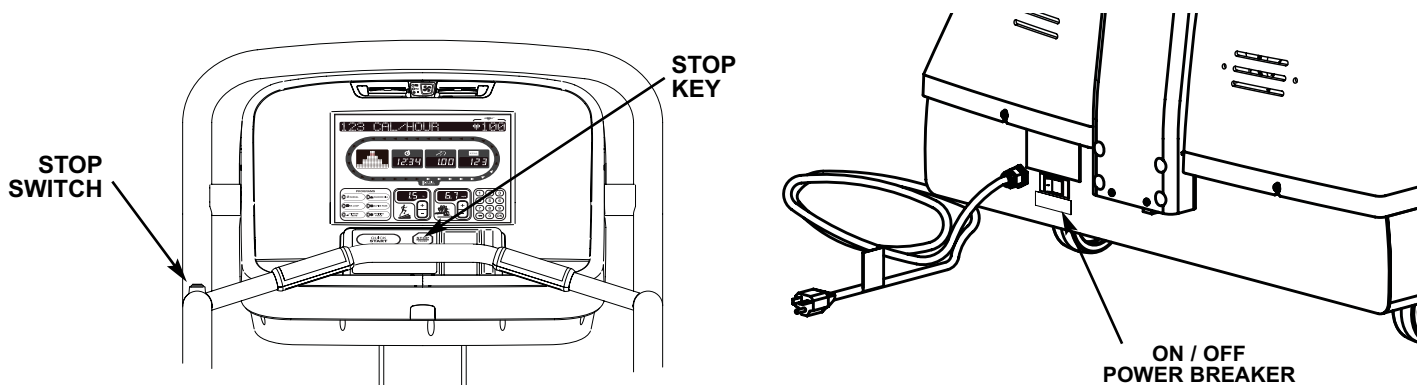

- **Emergency Stop:** In case of emergency, press the STOP on the display, or the stop switch on the left-hand side rail.
- **Immobilizing the Running Belt:** To power the unit, set the ON/OFF power breaker to the ON position. To turn the unit off, set the ON/OFF power breaker to the OFF position. When the unit is turned off, movement of the running belt is prevented.
- **Safety Lockout Feature:** Allows you to lock out the treadmill. When the treadmill is locked, the display shows the message "TREADMILL LOCKED, ENTER ID TO UNLOCK". The user must press "0", enter a 5-digit ID number (default=12345), then press ENTER to unlock the treadmill. The treadmill will then operate as normal (NOTE: The treadmill will lock back up if it is idle for 30 seconds). Use the LOCK OUT option in MAINTENANCE SETTINGS to enable/disable the lock out feature; use the LOCKOUT ID option to change the default ID (see Chapter 8).

DISPLAY CONTROL PANEL FEATURES

Your **STAR TRAC E SERIES TREADMILL** is equipped to provide you and your users unlimited exercise opportunities. Experiment with its features to find the right combination for your fitness regimen. The Display panel shown to the right provides the operating controls and display elements described in the following paragraphs:



QUICK START Key: Starts your treadmill running belt moving using a default weight of 155 pounds and a time limit of 99 minutes. **QUICK START** will allow you to manually operation of the treadmill too. The **QUICK START** key also serves as an "Enter" key in programming modes.





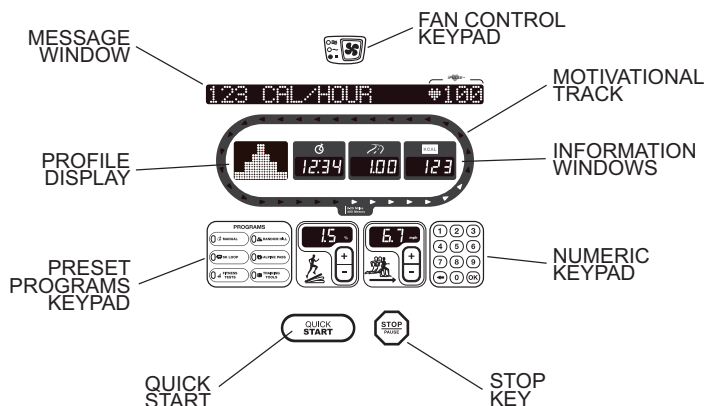

STOP Key: Pauses your treadmill when pressed once. Ends your workout when pressed twice.



Graphic Display: Traces your progress through each of the programs and allows you to anticipate changes in terrain. Display elements illuminate from left to right across the bottom of the display to indicate your progress through the course. At each step, display elements illuminate in columns to indicate your ascent up the gradient that is in effect.

Motivational Track: Shows your progress counter clockwise around 1/4 mile (400-meter) course, starting from the bottom center.



Speed Keys: During Program setup, press the  or  keys, respectively, until the desired speed appears in the Information Window, then, press START or  key. During a Program, press the  or  keys, respectively, to increase or decrease running belt speed in 0.1 miles per hour (mph) or 0.1 kilometers per hour (km/hr) increments. Speed cannot be higher than the established "MAXIMUM SPEED" parameter (see Chapter 8.) These keys repeat when pressed and held.

Speed Window: Shows the speed at which the user is walking/running, from 0.5 mph (0.8 kph) to 12.5 mph (20.0 kph).



Incline Keys: Adjust treadmill incline in 0.5% increments from 0% through 15% in manual operation. These keys repeat when pressed and held.

Incline Window: Shows the incline that the user is ascending, from 0% (easiest) to 15% (most difficult).



Numeric Keypad: Allow you to enter specific values for program parameters during program setup. The numeric keypad can also be used to adjust treadmill speed while the treadmill is operating.



Time Window: Shows the duration of your workout thus far in minutes and seconds.



Distance Window: Shows the total number of miles or kilometers you have walked or run thus far.



Calorie Window: Shows your aggregate caloric expenditure thus far in your workout.



Heart Rate Indicator: Pulsates to indicate your heart rate has been acquired through the use of the heart rate strap or heart rate grips.



Fan Key: Allows you to control the speed of the personal cooling fan, either OFF, LOW or HIGH.

Heart Rate Display: Shows your current heart rate in beats per minute (BPM) while wearing the heart rate strap or grasping the heart rate grips.

PROGRAM Keys: Allow you to access a desired workout program.

Information Window: Provides informational messages, prompts during program setup, notification when your workout is complete, and scrolling summarized workout data during and after a workout. Depending on the program completed and treadmill settings as set in Maintenance Settings mode, workout data may include:

- Time remaining
- Distance remaining - miles or kilometers
- Laps completed
- Calories expended per hour
- Minutes per mile/kilometer
- Vertical distance travelled - feet or meters
- METS
- Heart Rate

SOFT TRAC® SYSTEM

The Soft Trac® system is the treadmill's impact absorption system consisting of a floating deck on triple-cell neoprene strips that run under both sides of the deck for the entire length of the deck. This system is designed to protect ankles, knees, joints, and back while providing a comfortable walk or run. Whether you run to the front, middle, or rear of the deck you will enjoy the benefits of the Soft Trac® system.

HINTS AND TIPS FOR GETTING STARTED

The following hints and tips will assist in training your users to maximize the fitness benefits of your **STAR TRAC E SERIES TREADMILL**.







- **Walk or run at a rate that feels comfortable and most natural, yet is sufficiently vigorous to get a good cardio workout.**
- **Try different walking or running rhythms.** In manual operation, adjust your pace from low speed to high speed, then back to low. As you become more comfortable with your treadmill, try going faster or using the preset programs.

- **Watch the Graphic Display to anticipate terrain changes.** When you use the preset programs, the display shows changes in terrain as tall or short columns. The display also notifies you of incline changes with a series of beeps and a flashing display element.

QUICK START

Quick Start lets you begin your workout by simply pressing one key. Quick Start uses a default weight of 155 pounds and a time limit of 99 minutes. YOU control the treadmill speed, incline and distance for up to the maximum allowed program time.

To operate the Quick Start program:

1. Stand on the running belt and press the QUICK START key. The running belt slowly accelerates to its minimum speed of 0.5 mph (0.8 kph).
2. You can adjust the incline of the treadmill during the program:
 - You can adjust treadmill incline from 0 to 15%, in 0.5% increments. Press the  key to increase the treadmill incline; press the  key to decrease the treadmill incline.
3. You can adjust the speed of the treadmill during the program:
 - You can specify a desired speed from 0.5 to 12.5 mph (0.8 to 20.0 kph), using the numeric keypad. Use the ... keys to enter your desired speed, then press the  key to accept the entered speed.
 - You can adjust treadmill speed from 0.5 to 12.5 mph (0.8 to 20.0 kph), in 0.1 mph (or 0.1 kph) increments. Press the  key to increase the treadmill speed; press the  key to decrease the treadmill speed.
4. You can pause the program during your workout by pressing the STOP key once. The program will pause for a preset period of time (either 30, 45, 60, 90 or 120 seconds, as set in the Manager Mode). Press the START key BEFORE the pause timer expires to resume your program. The treadmill returns to its minimum speed when you exit the pause mode.
5. When you have reached your workout goal, the treadmill will enter the Cooldown cycle (see “Cooldown Cycle” for more information). If you wish to exit your program before you have reached your workout goal, press the STOP key twice. The treadmill will slow to a stop. (Press the STOP key once during a Pause to exit the program.)

PRESET PROGRAMS









The E Series Treadmill offers 12 preset programs to add variety and challenge to your workout.















ALPINE PASS AND RANDOM HILL

The climbing programs were designed for optimal interval training. By taking you through various terrains, your caloric expenditure is maximized and your cardiovascular capacity is improved. When wearing the heart rate strap, or grasping the heart rate contacts, your heart rate is constantly monitored and displayed in the Heart Rate Window to assist you in getting the most efficient workout possible. The ALPINE PASS offers a progressive high level of intensity workout. The RANDOM HILL program offers 250 different terrain configurations to add variety to your workout.







To operate a climbing program:

During program setup, you can use the  key to return to a previously accepted parameter.

1. Stand on the running belt; press the  or  key, as desired. You are prompted to enter your weight. You may enter your weight manually as described below.
 - If you do not use the weight scale to enter your weight, the treadmill will display a default weight of 155 pounds (70 kg). You may enter any weight from 1 to 500 pounds (1 to 226 kg).
 - You can enter your weight using the numeric keypad. Use the ... keys to enter your correct weight.
 - You can press the  or  key, as necessary, to increase or decrease the displayed weight in 1 pound (or 1 kg) increments.
 - When your correct weight has been entered, press the  key to accept the displayed value and advance to the next workout parameter.
2. You are prompted to enter a time goal.
 - The default time goal is 20 minutes. You may enter any time goal from 5 minutes to the maximum allowed program time.
 - You can enter your time goal using the numeric keypad. Use the ... keys to enter the desired time goal.

- You can press the  or  key, as necessary, to increase or decrease your time goal in 1 minute increments.
 - When your desired time goal has been entered, press the  key to accept the displayed value and advance to the next workout parameter.
3. You are prompted to enter a maximum speed.
 - You may enter any speed from 0.5 to 12.5 mph (0.8 to 20.0 kph).
 - You can enter the maximum speed using the numeric keypad. Use the ... keys to enter the desired maximum speed.
 - You can press the  or  key, as necessary, to increase or decrease the maximum speed in 0.1 unit increments.
 - When the desired maximum speed has been entered, press the  key to accept the displayed value and advance to the next workout parameter.
 4. You are prompted to enter a maximum incline.
 - You may enter any incline from 0.0% to 15.0%
 - You can enter the maximum incline using the numeric keypad. Use the ... keys to enter the desired maximum incline.
 - Press the  or  key, as necessary, to increase or decrease the maximum incline in 0.5% increments.
 - When the desired maximum incline has been entered, press the  key to accept the displayed value. You are prompted with a 3 second countdown, then the treadmill begins the program.
 5. You can adjust the incline of the treadmill during the program:
 - You can adjust treadmill incline from 0 to 15%, in 0.5% increments. Press the  key to increase the treadmill incline; press the  key to decrease the treadmill incline.
 6. You can adjust the speed of the treadmill during the program:

NOTE: Changing the current speed during a program will result in a corresponding change to the maximum speed specified during program setup.

 - You can specify a desired speed from 0.5 to 12.5 mph (0.8 to 20.0 kph), using the numeric keypad. Use the ... keys to enter your desired speed, then press the  key to accept the entered speed.
 - You can adjust treadmill speed from 0.5 to 12.5 mph (0.8 to 20.0 kph), in 0.1 mph (or 0.1 kph) increments. Press the  key to increase the treadmill speed; press the  key to decrease the treadmill speed.
 7. If desired, you can use the personal cooling fan during your workout (see “Using the Cooling Fan” for details).
 8. You can pause the program during your workout by pressing the STOP key once. The program will pause for a preset period of time (either 30, 45, 60, 90 or 120 seconds, as set in the Manager Mode). Press the QUICK START key BEFORE the pause timer expires to resume your program. The treadmill returns to its minimum speed when you exit the pause mode.
 9. If desired, you can jump to another climbing program at any time during your workout.
 - To jump to another climbing program, press the  or  key, as desired.
 10. When you have reached your workout goal, the treadmill will enter the Cooldown cycle (see “Cooldown Cycle” for more information). If you wish to exit your program before you have reached your workout goal, press the STOP key twice. The treadmill will slow to a stop. (Press the STOP key once during a Pause to exit the program.)

















MANUAL AND 5K LOOP

These programs were designed for the serious, as well as the recreational runner. You control the speed and incline to add variety and challenge to your workout. The patented Soft Trac® system protects ankles, knees, joints and back while providing a comfortable run. When wearing the heart rate strap, or grasping the heart rate contacts, your heart rate is constantly monitored and displayed in the Heart Rate Window to assist you in getting the most efficient workout possible.







The 5K LOOP provides a workout of a preset distance while the MANUAL program lets you create and run a profile based on a desired time goal.











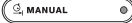



To operate the 5K Loop program:

During program setup, you can use the  key to return to a previously accepted parameter.



1. Stand on the running belt; press the  key. You are prompted to enter your weight. You may enter your weight manually as described below.
 - If you do not enter your weight, the treadmill will display a default weight of 155 pounds (70 kg). You may enter any weight from 1 to 500 pounds (1 to 226 kg).
 - You can enter your weight using the numeric keypad. Use the  keys to enter your correct weight.
 - You can press the  or  key, as necessary, to increase or decrease the displayed weight in 1 pound (or 1 kg) increments.
 - When your correct weight has been entered, press the  key to accept the displayed value. You are prompted with a 3 second countdown, then the treadmill begins the program.
2. You can adjust the incline of the treadmill during the program:
 - You can adjust treadmill incline from 0 to 15%, in 0.5% increments. Press the  key to increase the treadmill incline; press the  key to decrease the treadmill incline.
3. You can adjust the speed of the treadmill during the program:
 - You can specify a desired speed from 0.5 to 12.5 mph (0.8 to 20.0 kph), using the numeric keypad. Use the  keys to enter your desired speed, then press the  key to accept the entered speed.
 - You can adjust treadmill speed from 0.5 to 12.5 mph (0.8 to 20.0 kph), in 0.1 mph (or 0.1 kph) increments. Press the  key to increase the treadmill speed; press the  key to decrease the treadmill speed.
4. If desired, you can use the personal cooling fan during your workout (see “Using the Cooling Fan” for details).
5. You can pause the program during your workout by pressing the STOP key once. The program will pause for a preset period of time (either 30, 45, 60, 90 or 120 seconds, as set in the Manager Mode). Press the QUICK START key BEFORE the pause timer expires to resume your program. The treadmill returns to its minimum speed when you exit the pause mode.
6. When you have reached your workout goal, the treadmill will enter the Cooldown cycle (see “Cooldown Cycle” for more information). If you wish to exit your program before you have reached your workout goal, press the STOP key twice. The treadmill will slow to a stop. (Press the STOP key once during a Pause to exit the program.)

To operate the MANUAL program:

During program setup, you can use the  key to return to a previously accepted parameter. When entering program parameters, use the  keys to enter the desired value, or use the /  keys to scroll to the desired value.

1. Press the  key. You are prompted to enter your weight. You may enter your weight manually as described below.
 - If you do not enter your weight, the treadmill will display a default weight of 155 pounds (70 kg). You may enter any weight from 1 to 500 pounds (1 to 226 kg).
 - You can enter your weight using the numeric keypad. Use the  keys to enter your correct weight.
 - You can press the  or  key, as necessary, to increase or decrease the displayed weight in 1 pound (or 1 kg) increments.
 - When your correct weight has been entered, press the  key to accept the displayed value and proceed to the next parameter.
2. You will be prompted to select a workout time.
 - The default workout time is 99 minutes. You may enter any time from 5 to 99 minutes.
3. When your workout time has been entered, you are prompted with a 3 second countdown, then the treadmill begins the program.
4. You can adjust the incline of the treadmill during the program:
 - You can adjust treadmill incline from 0 to 15%, in 0.5% increments. Press the  key to increase the treadmill incline; press the  key to decrease the treadmill incline.
5. You can adjust the speed of the treadmill during the program:
 - You can specify a desired speed from 0.5 to 12.5 mph (0.8 to 20.0 kph), using the numeric keypad. Use the  keys

to enter your desired speed, then press the  key to accept the entered speed.

- You can adjust treadmill speed from 0.5 to 12.5 mph (0.8 to 20.0 kph), in 0.1 mph (or 0.1 kph) increments. Press the  key to increase the treadmill speed; press the  key to decrease the treadmill speed.
- 6. If desired, you can use the personal cooling fan during your workout (see “Using the Cooling Fan” for details).
- 7. You can pause the program during your workout by pressing the STOP key once. The program will pause for a preset period of time (either 30, 45, 60, 90 or 120 seconds, as set in the Manager Mode). Press the QUICK START key BEFORE the pause timer expires to resume your program. The treadmill returns to its minimum speed when you exit the pause mode.
- 8. When you have reached your workout goal, the treadmill will enter the Cooldown cycle (see “Cooldown Cycle” for more information). If you wish to exit your program before you have reached your workout goal, press the STOP key twice. The treadmill will slow to a stop. (Press the STOP key once during a Pause to exit the program.)

TRAINING TOOLS

The TRAINING TOOLS program includes the HEART RATE TRAINING (Dynamic Heart Rate Control and Constant Heart Rate Control) program.

HEART RATE CONTROL PROGRAMS

NOTE: For best results, use a heart rate strap. If user is wearing a heart rate strap, the machine will automatically use the data from the heart rate strap. Contact heart rate grips may not give an accurate heart rate when exercising over 4 mph.









To operate the Dynamic Heart Rate Control program:

This heart rate feature is designed to gradually elevate your heart rate to the upper end of your selected training range, then gradually decrease your heart rate to the lower end of your selected training range using speed and incline. During the workout, this cycle will repeat several times, creating an interval training effect that is customized to the user's desired heart rate training range.

During program setup, there must be at least an 18 BPM difference between the lower heart rate limit and upper heart rate limit to ensure an interval workout.

By including interval exercise in your regular aerobic program, greater effects are noticed. Your heart and muscles will adapt to the increases in demand by utilizing stored calories for energy more effectively. Dynamic Heart Rate Control may potentially result in more calories expended. It will strengthen the heart, provide stress relief and variety to a workout. This program is more effective in training the body to remove excess lactic acid from the muscles.

During program setup, you can use the  key to return to a previously accepted parameter.

1. Stand on the running belt; press the  key.
2. You are prompted to select the desired TRAINING TOOLS program. Press the  key to select the HR TRAINING programs, then press the  key when prompted to select Dynamic Heart Rate Control.
3. The Information Window displays the message “DYNAMIC PROGRAM VARIES SPEED AND INCLINE TO ALTER YOUR HEART RATE BETWEEN LIMITS.” Press the  key to continue.
4. You are prompted to enter your weight. You may enter your weight manually as described below.
 - If you do not enter your weight, the treadmill will display a default weight of 155 pounds (70 kg). You may enter any weight from 1 to 500 pounds (1 to 226 kg).
 - You can enter your weight using the numeric keypad. Use the ... keys to enter your correct weight.
 - You can press the  or  key, as necessary, to increase or decrease the displayed weight in 1 pound (or 1 kg) incre-



To calculate your training zone, use the following formulas:
(theoretical max HR = 220 - Age)

Heart Rate Training Range Upper Level



























$$\frac{\text{Your Theoretical Max}}{\text{Training Range Upper Limit}} \times 0.75 =$$

Heart Rate Training Range Lower Level

$$\frac{\text{Your Theoretical Max}}{\text{Training Range Lower Limit}} \times 0.60 =$$

NOTE: Calculating your theoretical maximum heart rate using age is an approximation. For more information, please contact a fitness professional or doctor.





























ments.

- When your correct weight has been entered, press the  key to accept the displayed value and advance to the next workout parameter.
5. You are prompted to enter a workout time.
 - The default workout time is 99 minutes. You may enter any time from 5 to 99 minutes.
 - You can enter a workout time using the numeric keypad. Use the ... keys to enter the desired workout time.
 - You can press the  or  key, as necessary, to increase or decrease workout time in 1 minute increments.
 - When the desired workout time has been entered, press the  key to accept the displayed value and advance to the next parameter.
 6. You are prompted to enter your age.
 - You may enter any age from 1 to 99 years.
 - You can enter your age using the numeric keypad. Use the ... keys to enter the desired age.
 - You can press the  or  key, as necessary, to increase or decrease your age in 1 year increments.
 - When your correct age has been entered, press the  key to accept the displayed value and advance to the next parameter.
 7. You are prompted to enter your upper heart rate limit.
 - The treadmill displays a default upper heart rate limit based on 75% of your theoretical maximum heart rate (220 BPM - age).
 - You can enter a new upper heart rate limit using the numeric keypad. Use the ... keys to enter the desired upper heart rate limit. You may enter any value from 90 to 200 BPM.
 - You can use the  or  key, as necessary, to increase or decrease the displayed upper heart rate limit in 1 BPM increments.
 - When the desired upper heart rate limit has been entered, press the  key to accept the displayed value and advance to the next parameter.
 8. You are prompted to enter your lower heart rate limit.
 - The treadmill displays a default lower heart rate limit based on 60% of your theoretical maximum heart rate (220 BPM - age).
 - You can enter a new lower heart rate limit using the numeric keypad. Use the ... keys to enter the desired lower heart rate limit. You may enter any value from 70 BPM to 20 BPM less than the entered upper heart rate limit.
 - You can use the  or  key, as necessary, to increase or decrease the displayed lower heart rate limit in 1 BPM increments.
 - When the desired lower heart rate limit has been entered, press the  key to accept the displayed value and advance to the next parameter.
 9. You are prompted to enter a maximum speed.
 - You may enter any speed from 2.0 to 7.0 mph (3.0 to 11.0 kph).
 - You can enter the maximum speed using the numeric keypad. Use the ... keys to enter the desired maximum speed.
 - You can press the  or  key, as necessary, to increase or decrease the maximum speed in 0.1 unit increments.
 - When the desired maximum speed has been entered, press the  key to accept the displayed value. You are prompted with a 3 second countdown, then the treadmill begins the program.
- **During the Workout**
 1. During the heart rate controlled workout, the treadmill will respond every 20 seconds to your heart rate. The treadmill uses your heart rate to adjust the intensity of the workout. The treadmill will adjust speed and (if necessary) incline to elevate your heart rate to the specified upper limit, then it will gradually decrease incline and (if necessary) speed to lower your heart rate to the specified lower limit. A typical 20 minute workout may repeat this pattern 3 to 5 times.
 2. The program will display various motivational and informative messages throughout the workout. After the workout is complete, the program will scroll the summary workout information.

3. If, for any reason, the treadmill does not detect your heart rate signal, the treadmill will gradually decrease the workout intensity. After the heart rate signal is re-acquired the interval training program will resume.

To operate the Constant Heart Rate Control program:

This heart rate feature is designed to maintain your heart rate at a constant level by varying the treadmill incline during your workout. Please note that your heart rate may vary above and below your target heart rate during this program.

1. Stand on the running belt; press the  key.
2. You are prompted to select the desired TRAINING TOOLS program. Press the  key to select the HR TRAINING programs, then press the  key when prompted to select Constant Heart Rate Control.
3. The Information Window displays the message “CONSTANT HR PROGRAM VARIES INCLINE TO MAINTAIN CONSTANT HEART RATE .” Press the  key to continue.
4. You are prompted to enter your weight. You may enter your weight manually as described below.
 - If you do not enter your weight, the treadmill will display a default weight of 155 pounds (70 kg). You may enter any weight from 1 to 500 pounds (1 to 226 kg).
 - You can enter your weight using the numeric keypad. Use the  keys to enter your correct weight.
 - You can press the  or  key, as necessary, to increase or decrease the displayed weight in 1 pound (or 1 kg) increments.
 - When your correct weight has been entered, press the  key to accept the displayed value and advance to the next workout parameter.
5. You are prompted to enter a workout time.
 - The default workout time is 99 minutes. You may enter any time from 5 to 99 minutes.
 - You can enter a workout time using the numeric keypad. Use the  keys to enter the desired workout time.
 - You can press the  or  key, as necessary, to increase or decrease workout time in 1 minute increments.
 - When the desired workout time has been entered, press the  key to accept the displayed value and advance to the next parameter.
6. You are prompted to enter your age.
 - You may enter any age from 1 to 99 years.
 - You can enter your age using the numeric keypad. Use the  keys to enter the desired age.
 - You can press the  or  key, as necessary, to increase or decrease your age in 1 year increments.
 - When your correct age has been entered, press the  key to accept the displayed value and advance to the next parameter.
7. You are prompted to enter a target heart rate. The treadmill displays a default target heart rate that is based on 70% of your theoretical maximum heart rate (220 BPM - age). You may enter any value from 70 to 200 BPM.
 - You can enter a new target heart rate using the numeric keypad. Use the  keys to enter the desired target heart rate . You may enter any value from 70 to 200 BPM.
 - You can use the  or  key, as necessary, to increase or decrease the displayed target heart rate in 1 BPM increments.
 - When the desired target heart rate has been entered, press the  key to accept the displayed value and advance to the next parameter.
8. You are prompted to enter a maximum speed.
 - You may enter any speed from 2.0 to 12.5 mph (3.2 to 20.0 kph).
 - You can enter the maximum speed using the numeric keypad. Use the  keys to enter the desired maximum speed.
 - You can press the  or  key, as necessary, to increase or decrease the maximum speed in 0.1 unit increments.
 - When the desired maximum speed has been entered, press the  key to accept the displayed value. You are prompted with a 3 second countdown, then the treadmill begins the program.
9. If desired, you can use the personal fan during your workout (see “Using the Personal Fan” for details).

10. You can scroll through workout data during the program (see “Viewing Workout Data During a Program” for details).
11. If you wish to pause the program, press the STOP key once. Caution: If you press the STOP key twice the program will end.
12. When you have reached your workout goal, the treadmill will enter the Cooldown cycle (see “Cooldown Cycle” for more information). If you wish to exit your program before you have reached your workout goal, press the STOP key twice. The treadmill will slow to a stop. (Press the STOP key once during a pause to exit the program.)

FITNESS TESTS PROGRAMS























NOTE: For best results, use a heart rate strap. If user is wearing a heart rate strap, the machine will automatically use the data from the heart rate strap. Contact heart rate grips may not give an accurate heart rate when exercising over 4 mph.

To operate the Fitness Test program:

The Fitness Test is a modified version of the Balke and Ware protocol for maximal VO₂ treadmill testing. The original Balke-Ware protocol is a 20 minute test with a maximum elevation of 20%. Since most users prefer an 8-12 minute test and the Star Trac E SERIES TREADMILLS have a maximum elevation of 15%, the test has been modified to last 12 minutes with a maximum incline of 12%. This protocol is appropriate for all users but mostly used for older, deconditioned, or patient groups. During the Fitness Test, treadmill speed remains at a constant 3.4 mph. Treadmill incline is set at 0% during the first minute, increases to 2% during the second minute, and increases by 1% per minute for the remainder of the test. Your heart rate results are compared with charted data for your corresponding age and gender. Test results include your calculated VO₂ max. VO₂ max is a physiological measurement of a bodies ability to absorb oxygen and has specific correlation to your fitness level. See “Calculation for VO₂ Max” for more information.

NOTE: You must wear the heart rate strap during the Fitness Test to monitor your heart rate.

During program setup, you can use the  key to return to a previously accepted parameter.

1. Stand on the running belt; press the  key.
2. You are prompted to select the desired FITNESS TESTS program. Press the  key to select the FITNESS TESTS programs, then press the  key when prompted to select the Fitness Test.
3. The Information Window displays the message “THIS IS A SUB-MAXIMAL VO₂ FIT TEST THAT WILL EVALUATE YOUR FITNESS LEVEL.” Press the  key to continue.
4. You are prompted to enter your weight. You may enter your weight manually as described below.
 - If you do not enter your weight, the treadmill will display a default weight of 155 pounds (70 kg). You may enter any weight from 1 to 500 pounds (1 to 226 kg).
 - You can enter your weight using the numeric keypad. Use the  keys to enter your correct weight.
 - You can press the  or  key, as necessary, to increase or decrease the displayed weight in 1 pound (or 1 kg) increments.
 - When your correct weight has been entered, press the  key to accept the displayed value and advance to the next parameter.
5. You are prompted to enter your gender.
 - Press the  key for “Male”; press the  key for “Female.”
 - When your correct gender has been entered, press the  key to accept the displayed value and advance to the next parameter.
6. You are prompted to enter your age.
 - You may enter any age from 1 to 99 years.
 - You can enter your age using the numeric keypad. Use the  keys to enter the desired age.
 - You can press the  or  key, as necessary, to increase or decrease your age in 1 year increments.
 - When your correct age has been entered, press the  key to accept the displayed value.
7. The Information Window displays the message “TEST RUNS AT 3.4 MPH, ELEVATING FROM INCLINE 0 TO 12.” Press the  key to continue.
8. The Information Window displays the message “TEST WILL TERMINATE IF YOUR HR EXCEEDS 150 FOR MORE THAN 1

MINUTE.” Press the  key to continue. You are prompted with a 3 second countdown, then the treadmill begins the program.

9. The FIT TEST runs for 12 minutes. During the test, the treadmill speed is set at 3.4 mph. The treadmill incline begins at 0% for the first minute, increases to 2% for the second minute, and increases by 1% thereafter for each remaining minute to a maximum incline of 12% during the final minute of the test.

During the test, you MAY NOT adjust treadmill speed or incline, and you MAY NOT pause the program. If your heart rate exceeds 150 BPM for more than one minute, the test will terminate automatically.

10. If desired, you can use the personal cooling fan during the FIT TEST (see “Using the Cooling Fan” for details).
11. When you have reached your workout goal, the treadmill will enter the Cooldown cycle (see “Cooldown Cycle” for more information). If you wish to exit your program before you have reached your workout goal, press the STOP key once. The treadmill will slow to a stop, and the test will terminate.









To operate the Firefighter Test program:

The Firefighter test found in the Star Trac E Series Treadmill is based on the Gerkin Protocol developed by Dr. Richard Gerkin of the Phoenix (Arizona) Fire Department. It is a sub-maximal graded treadmill evaluation used by many Fire Departments across the United States to assess the condition of the firefighters. The program operates as follows:

- **Warm-Up:** During warm-up, the treadmill runs at 3.0 mph (4.8 kph), 0% incline for 3 minutes.
- **Stage 1:** At 3 minutes, treadmill speed increases gradually to 4.5 mph (7.2 kph). The test begins at 4.5 mph (7.2 kph). During the test, heart rate is continuously monitored.
- **Stage 2:** After one minute, treadmill incline increases to 2%.
- **Stage 3:** After one minute, treadmill speed increases to 5.0 mph (8.0 kph).
- **Stages 4 through 11:** After every odd minute, treadmill incline increases an additional 2%. After every even minute, treadmill speed increases by 0.5 mph (0.8 kph). Once the user's heart rate exceeds the target HR (85% of maximum), the individual continues the evaluation for an additional 15 seconds. During this 15 second period, the evaluation remains at the stage where the target HR is exceeded, with speed or grade unchanged. If the HR does not return to or below the target HR, the evaluation ends and the final evaluation stage is recorded. If the HR returns to or below the target HR, the program continues at the point where it would have been had the program not stabilized for 15 seconds.
- **Test Completion:** The test is completed when user heart rate exceeds target for more than 15 seconds or the user completes all 11 stages, whichever occurs first. The treadmill will enter a Cooldown cycle for 3 minutes at 3.0 mph (4.8 kph), 0% incline.

NOTE: You must wear the heart rate strap during the Firefighter Test to monitor your heart rate.

During program setup, you can use the  key to return to a previously accepted parameter.

1. Stand on the running belt; press the  key.
2. You are prompted to select the desired TRAINING TOOLS program. Press the  key to select the FITNESS TESTS programs, then press the  key when prompted to select the Firefighter Test.
3. The Information Window displays the message “THIS IS A SUB-MAXIMAL VO2 FIT TEST THAT WILL EVALUATE YOUR FITNESS LEVEL.” Press the  key to continue.
4. You are prompted to enter your weight. You may enter your weight manually as described below, or you may use the weight scale to enter your weight (ELITE only; see “Using the Weight Scale” for details).
 - If you do not use the weight scale to enter your weight, the treadmill will display a default weight of 155 pounds (70 kg). You may enter any weight from 1 to 500 pounds (1 to 226 kg).
 - You can enter your weight using the numeric keypad. Use the  keys to enter your correct weight.
 - You can press the  or  key, as necessary, to increase or decrease the displayed weight in 1 pound (or 1 kg) increments.
 - When your correct weight has been entered, press the  key to accept the displayed value and advance to the next parameter.

5. You are prompted to enter your gender.

- Press the ① key for “Male”; press the ② key for “Female.”
- When your correct gender has been entered, press the Ⓞ key to accept the displayed value and advance to the next parameter.

6. You are prompted to enter your age.

- You may enter any age from 1 to 99 years.
- You can enter your age using the numeric keypad. Use the ①***② keys to enter the desired age.
- You can press the \pm (▲) or \pm (▼) key, as necessary, to increase or decrease your age in 1 year increments.
- When your correct age has been entered, press the Ⓞ key to accept the displayed value and advance to the next parameter.

7. You are prompted with your maximum heart rate limit.

- The treadmill displays a default upper heart rate limit based on 75% of your theoretical maximum heart rate (220 BPM - age). You cannot enter a new maximum heart rate.

8. The Information Window displays the message “BEGIN WARMUP AT 3.0 MPH AND 00% INCLINE FOR 3 MINUTES.” Press the Ⓞ key to continue. You are prompted with a 3 second countdown, then the treadmill begins the program.

9. At 2 minutes and 30 seconds into the warmup, the Information Window displays the message “TEST BEGINS AT 4.5 MPH AND 0% INCLINE, AND INCREASES IN 1-MINUTE STAGES.” followed by “TEST IS COMPLETE WHEN YOUR HR EXCEED ### (your maximum heart rate) FOR MORE THAN 15 SECONDS.”

During the test, you MAY NOT adjust treadmill speed or incline, and you MAY NOT pause the program. If your heart rate exceeds your entered maximum heart rate for more than 15 seconds, the test will terminate automatically.

10. If desired, you can use the personal cooling fan during the FIT TEST (see “Using the Cooling Fan” for details).

11. When you have reached your workout goal, the treadmill will enter the Cooldown cycle (see “Cooldown Cycle” for more information). If you wish to exit your program before you have reached your workout goal, press the STOP key twice. The treadmill will slow to a stop. (Press the STOP key once during a Pause to exit the program.)

SUBMAXIMAL TREADMILL EVALUATION CONVERSION TABLE

Stage	Time (begin)	Time (end)	Converted VO2max	Speed (mph)	Grade (%)
1	0:00	1:00	31.15	4.5	0
2.1	1:00	1:15	32.55	4.5	2
2.2	1:15	1:30	33.6		
2.3	1:30	1:45	34.65		
2.4	1:45	2:00	35.35		
3.1	2:00	2:15	37.45	5.0	2
3.2	2:15	2:30	39.55		
3.3	2:30	2:45	41.3		
3.4	2:45	3:00	43.4		
4.1	3:00	3:15	44.1	5.0	4
4.2	3:15	3:30	45.15		
4.3	3:30	3:45	46.2		
4.4	3:45	4:00	46.5		
5.1	4:00	4:15	48.6	5.5	4
5.2	4:15	4:30	50		
5.3	4:30	4:45	51.4		
5.4	4:45	5:00	52.8		
6.1	5:00	5:15	53.9	5.5	6
6.2	5:15	5:30	54.9		
6.3	5:30	5:45	56		
6.4	5:45	6:00	57		
7.1	6:00	6:15	57.7	6.0	6
7.2	6:15	6:30	58.8		
7.3	6:30	6:45	60.2		
7.4	6:45	7:00	61.2		
8.1	7:00	7:15	62.3	6.0	8
8.2	7:15	7:30	63.3		
8.3	7:30	7:45	64		
8.4	7:45	8:00	65		
9.1	8:00	8:15	66.5	6.5	8
9.2	8:15	8:30	68.2		
9.3	8:30	8:45	69		
9.4	8:45	9:00	70.7		
10.1	9:00	9:15	72.1	6.5	10
10.2	9:15	9:30	73.1		
10.3	9:30	9:45	73.8		
10.4	9:45	10:00	74.9		
11.1	10:00	10:15	76.3		10
11.2	10:15	10:30	77		
11.3	10:30	10:45	79.1		
11.4	10:45	11:00	80		



























Use the accompanying “Submaximal Treadmill Evaluation Conversion Table” to determine your score based on your Converted VO2 max (see “Calculation for VO2 Max” for more information).

To operate the Military Test programs:

The Military Test programs provide workouts of a preset distance, as required by the Army, Navy, USMC and USAF. As the names imply, the object of each test is to complete the run distance as quickly as possible. At the completion of the test, a time-based score (defined by the respective branch of the Military) is returned to the user. Each test begins with treadmill incline at 1% (which best simulates outdoor running).

NOTE: You must wear the heart rate strap during the Army 2 Mile Run to monitor your heart rate.

During program setup, you can use the  key to return to a previously accepted parameter.

1. Stand on the running belt; press the  key.
2. You are prompted to select the desired TRAINING TOOLS program. Press the  key to select the FITNESS TESTS programs, then press the  key when prompted to select the Military Tests. Press the key corresponding to the desired test:
 - Press the  key for the Army 2 Mile Run.
 - Press the  key for the USMC 3 Mile Run.
 - Press the  key for the USAF 1.5 Mile Run.
 - Press the  key for the Navy 1.5 Mile Run.
3. The Information Window displays the message “THIS IS A # (distance) RUN TO BE COMPLETED AS QUICKLY AS POSSIBLE.” Press the  key to continue.
4. You are prompted to enter your weight. You may enter your weight manually as described below, or you may use the weight scale to enter your weight (ELITE only; see “Using the Weight Scale” for details).
 - If you do not use the weight scale to enter your weight, the treadmill will display a default weight of 155 pounds (70 kg). You may enter any weight from 1 to 500 pounds (1 to 226 kg).
 - You can enter your weight using the numeric keypad. Use the ... keys to enter your correct weight.
 - You can press the  or  key, as necessary, to increase or decrease the displayed weight in 1 pound (or 1 kg) increments.
 - When your correct weight has been entered, press the  key to accept the displayed value and advance to the next parameter.
5. You are prompted to enter your gender.
 - Press the  key for “Male”; press the  key for “Female.”
 - When your correct gender has been entered, press the  key to accept the displayed value and advance to the next parameter.
6. You are prompted to enter your age.
 - You may enter any age from 1 to 99 years.
 - You can enter your age using the numeric keypad. Use the ... keys to enter the desired age.
 - You can press the  or  key, as necessary, to increase or decrease your age in 1 year increments.
 - When your correct age has been entered, press the  key to accept the displayed value and advance to the next parameter.
8. You are prompted to enter an initial running speed.
 - You may enter any speed from 0.5 to 12.5 mph (0.8 to 20.0 kph).
 - You can enter the maximum speed using the numeric keypad. Use the ... keys to enter the desired maximum speed.
 - You can press the  or  key, as necessary, to increase or decrease the maximum speed in 0.1 unit increments.
 - When the desired maximum speed has been entered, press the  key to accept the displayed value.
8. The Information Window displays the message “YOU MAY CHANGE SPEED AND INCLINE DURING THE TEST”. for the Army 2 Mile Run, USMC 3 Mile Run and USAF 1.5 Mile Run, or “YOU MAY CHANGE SPEED DURING THE TEST.” for the Navy 1.5 Mile Run Press the START or  key to continue. You are prompted with a 3 second countdown, then the treadmill begins the program.

9. You can adjust the incline of the treadmill during the program:

NOTE: You cannot change the incline for the Navy 1.5 Mile Run.

- You can adjust treadmill incline from 0 to 15%, in 0.5% increments. Press the key to increase the treadmill incline; press the key to decrease the treadmill incline.

10. You can adjust the speed of the treadmill during the program:

- You can specify a desired speed from 0.5 to 12.5 mph (0.8 to 20.0 kph), using the numeric keypad. Use the ... keys to enter your desired speed, then press the key to accept the entered speed.

- You can adjust treadmill speed from 0.5 to 12.5 mph (0.8 to 20.0 kph), in 0.1 mph (or 0.1 kph) increments. Press the key to increase the treadmill speed; press the key to decrease the treadmill speed.

11. If desired, you can use the personal cooling fan during your workout (see “Using the Cooling Fan” for details).

12. When you have reached your workout goal, the treadmill will enter the Cooldown cycle (see “Cooldown Cycle” for more information). If you wish to exit your program before you have reached your workout goal, press the STOP key once. The treadmill will slow to a stop, and the test will terminate.

CALCULATION FOR VO2 MAX

VO2 is calculated for two work stages where heart rate is between 115 and 150 BPM using the following equation:

$$VO2 = HC + VC + 3.5 \text{ ml/kg/min}$$

Where **HC** is the horizontal component and **VC** in the vertical component

Using the two VO2 values, the slope, **b**, is calculated using the following equation:

$$b = \frac{SM2 - SM1}{HR2 - HR1}$$

where **SM1** is the VO2 for the first stage, **SM2** is the VO2 for the second stage, **HR1** is the heart rate at the end of the first stage that was used to calculate VO2, and **HR2** is the heart rate at the end of the second stage that was used to calculate VO2.

VO2 max is then predicted using the following equation:

$$VO2 \text{ Max} = SM2 + b(HR_{max} - HR2)$$

where **HRmax** is the predicted max HR using the 220-age figure.

Refer to the accompanying “Analyses of VO2 Max Scores” charts to determine your fitness level.

ANALYSES OF VO2 MAX SCORES

Female (values in ml/kg/min)

Age	Low	Fair	Good	Excellent	Superior
1-19	<30.9	31.0 - 34.9	35.0 - 38.9	39.0 - 41.9	>41.9
20-29	<28.9	29.0 - 32.9	33.0 - 36.9	37.0 - 41.0	>41.0
30-39	<26.9	27.0 - 31.4	31.5 - 35.6	35.7 - 40.0	>40.0
40-49	<24.4	24.5 - 28.9	29.0 - 32.8	32.9 - 36.9	>36.9
50-59	<22.7	22.8 - 26.9	27.0 - 31.4	31.5 - 35.7	>35.7
60+	<20.1	20.2 - 24.4	24.5 - 30.2	30.3 - 31.4	>31.4

Male (values in ml/kg/min)

Age	Low	Fair	Good	Excellent	Superior
1-19	<38.3	38.4 - 45.1	45.2 - 50.9	51.0 - 55.9	>55.9
20-29	<36.4	36.5 - 42.4	42.5 - 46.4	46.5 - 52.4	>52.4
30-39	<35.4	35.5 - 40.9	41.0 - 44.9	45.0 - 49.4	>49.4
40-49	<33.5	33.6 - 38.9	39.0 - 43.7	43.8 - 48.0	>48.0
50-59	<30.9	31.0 - 35.7	35.8 - 40.9	41.0 - 45.3	>45.3
60+	<26.0	26.1 - 32.2	32.3 - 36.4	36.5 - 44.2	>44.2

COOLDOWN CYCLE

Once you have completed your workout program, the treadmill enters a 2-minute cooldown cycle.



To operate the treadmill during Cooldown:

1. You can adjust the incline of the treadmill during the program:

- You can adjust treadmill incline from 0 to 15%, in 0.5% increments. Press the key to increase the treadmill incline; press the key to decrease the treadmill incline.

2. You can adjust the speed of the treadmill during the program:

- You can specify a desired speed from 0.5 to 10.0 mph (0.8 to 16.0 kph) for 110-volt units or 0.5 to 12.0 mph (0.8 to 19.3 kph) for 220-volt units, using the numeric keypad. Use the ... keys to enter your desired speed, then press the START or ENTER key to accept the entered speed.

- You can adjust treadmill speed from 0.5 to 10.0 mph (0.8 to 16.0 kph) for 110-volt units or 0.5 to 12.0 mph (0.8 to 19.3 kph) for 220-volt units, in 0.1 mph (or 0.1 kph) increments. Press the  key to increase the treadmill speed; press the  key to decrease the treadmill speed.
3. When the cooldown cycle ends, the treadmill will slow to a stop. If you wish to exit the cooldown cycle before it ends automatically, press the STOP key. The treadmill will slow to a stop.

USING THE COOLING FAN

The PRO Treadmill is equipped with a built-in cooling fan to increase your comfort during a workout. You can control the fan speed during your workout.

To operate the cooling fan:

- Press the FAN key once to set the fan speed to low.
- Press the FAN key a second time to set the fan speed to high.
- Press the FAN key a third time to turn the cooling fan off.
- The fan will remain at the set speed if you pause your program. The fan will turn off automatically if you exit your workout, or when you complete your program.

If the cooling fan is not available for use, the Information Window displays an advisory message when you press the FAN key.

HEART RATE MONITORING



Heart rate monitoring allows you to determine if your treadmill workout is too challenging or not challenging enough. Monitoring heart rate is easy with the **STAR TRAC E SERIES TREADMILL**, which provides both polar chest strap compatibility, and heart rate grips that allow you to monitor your heart automatically. Your goal will be to keep your exercise heart rate at 60 to 90 percent of the theoretical maximum for your age as listed on the Target Heart Rate table and graph in chapter 6.

NOTE: The Heart Rate monitor is not a medical test, nor is it designed as a medical test. It is simply a guide to target heart rate training. Please consult with your physician prior to engaging in any strenuous physical activity.

IMPORTANT: The manufacturer does not warrant the heart rate system performance on this product, as the heart rate system performance varies, based on a user's physiology, fitness level, age, method of use and other factors. Furthermore, the heart rate system is not for medical use.

CONTACT HEART RATE MONITORING



You may use the heart rate contact grips to automatically check your heart rate. Just follow these steps:

1. Grasp the stainless steel heart rate contact grips; you do not have to squeeze tightly.
2. When a heart rate has been detected, the  icon displays in the Information Window, indicating a calculation is taking place.
3. When your heart rate has been acquired, the  icon will begin pulsating, and your heart rate in beats per minute (BPM) will be displayed in the Information Window continuously.
4. Release the Heart Rate grips if you wish to remove your heart rate from the display.

NOTE: Contact heart rate may not give accurate BPM when exercising over 4.0 mph (6.4 kph).

CHEST STRAP HEART RATE MONITORING

You may use the heart rate strap to automatically check your heart rate. Just follow these steps:

1. Before beginning your workout, or during a pause, moisten the back of the transmitter on the heart rate strap (not included). Place the strap snugly around your chest with the transmitter resting directly over your sternum.
2. When a heart rate has been detected, the  indicator illuminates, indicating a calculation is taking place.
3. When your heart rate has been acquired, the  indicator will begin pulsating, and your heart rate in beats per minute (BPM) will be displayed in the Heart Rate Window continuously.
4. Remove the heart rate strap, if you wish to remove your heart rate from the display.

NOTE: The performance of the transmitter may be affected by body types, body oils, metal in clothing, and outside electrical interference. Always be sure that the transmitter and skin are in good contact. Avoid operating other electrical equipment near your treadmill when you use the heart rate strap.

To assist you in your training program, this chapter provides you with exercise principles, tips for training and hints to stay motivated climbing up the conditioning ladder.

THE FIRST STEP TO A BETTER LIFESTYLE

With the **STAR TRAC E SERIES TREADMILL**, you've taken an important first step to achieving your fitness goal. But, it's important to have the right fitness tools to stay motivated and achieve results. About half of all people who start an exercise program quit within 6-12 months. What is the key to success for the other half? Motivation!

As you may know, exercise reduces the factors associated with the development of heart disease, hypertension, diabetes, obesity and back disorders. Researchers have concluded that a healthful life-style including regular exercise can extend your life expectancy by as much as fifteen years! More importantly, exercise will help make all your years - no matter how many there are - productive and enjoyable.

What constitutes a regular exercise regimen? If you stick with a consistent workout program for 30 minutes, three times a week, for 3 months, you will be on your way to a long-term fitness program. Part of the motivation for a regular exercise regimen will stem from the results you will both see and feel after three months. In fact, many exercisers start to experience results in as early as one week!

GETTING STARTED - WALKERS AND RUNNERS

For fitness newcomers or veterans, the **STAR TRAC E SERIES TREADMILL** offers tailor-made walking and running programs. The following information will be useful when developing your own exercise program.

Assessing Fitness Level

Conducting a cardiovascular endurance assessment is a great way to start an exercise regimen. With the simple 1 mile Fit Test on your Star Trac E SERIES treadmill, the results provide great baseline information to help determine your proper workout intensity levels, and it serves as a great motivational tool for showing improvements over time. Below is a simple test to follow. This assessment should only be used with apparently healthy adults.

The Fit Test is a modified version of the Balke and Ware protocol for maximal VO₂ treadmill testing. The Fit Test requires 12 minutes to complete. During the Fit Test, treadmill speed remains at a constant 3.4 mph. Treadmill incline is set at 0% during the first minute, increases to 2% during the second minute, and increases by 1% per minute for the remainder of the test. Your heart rate results are compared with charted data for your corresponding age and gender. Test results are given on a scale of 1 to 10, and include your calculated VO₂ max. VO₂ max is a physiological measurement of a body's ability to absorb oxygen and has specific correlation to your fitness level.

The Warm Up

Warming-up prepares you for physical activity by increasing body temperature, allowing the muscles to relax and contract more smoothly and efficiently, and lubricating the joints. Good warm-up exercises include walking, bicycling, jogging and light calisthenics. Proper warm-up may also help prevent injuries and reduce the likelihood of cardiac abnormalities. A mild sweat is a good indication that the body is sufficiently warmed-up.

Pre-Exercise Stretching

A flexibility program prior to walking or running is designed to help improve performance and reduce the risk of injury during the activity. When you are stretching, remember these simple rules:

- An active warm-up is recommended prior to vigorous stretching exercises. If stretches are performed, they should be done with caution, so as to not over stretch muscles.
- Do not force a stretch. The degree of stretching should not cause significant pain.
- Hold the stretch for 10 to 15 seconds without bouncing.
- Repeat each stretch two or three times for increased flexibility.
- Try to maintain good posture and remember to breathe during the stretch.

The following muscle groups should be stretched/warmed up for any walking or running program:

- | | | |
|--------------|----------------|--------------------|
| ■ Quadriceps | ■ Glutes | ■ Chest |
| ■ Hamstrings | ■ Inner thighs | ■ Shoulder muscles |
| ■ Calves | ■ Back muscles | ■ Hip flexors |

F.I.T. Principle

Every cardiovascular program should be developed based on frequency, intensity and duration.

1) **Frequency** - the number of exercise sessions per week.

Regular exercise should be performed at least three or four days a week to be beneficial, although fewer sessions may be sufficient for some. Those in superior physical condition typically train five to seven days per week.

2) **Intensity** - how hard each exercise is.

Intensity is dependent upon one's fitness level. The range established by American College of Sports Medicine is 60% to 90% of maximal heart rate. If you are a beginning exerciser, maintaining an intensity level around 60% is beneficial. Typically, an estimated heart rate range is determined using a formula of 220-Age, factoring in resting heart rate, then multiplying by the desired percentage. See the accompanying chart on this page.

The **STAR TRAC E SERIES TREADMILL** offers both contact heart rate grips and heart rate strap compatibility, providing for easy monitoring of your heart rate during your workout. However, if you need to monitor your pulse manually, find the carotid or radial artery with your index finger, take a ten second count and multiply by six to determine your heart rate.

RPE SCALE	
0	Nothing at all
1	Very, Very Easy
2	Very Easy
3	Easy
4	Moderate
5	Moderate/Strong
6	Strong
7	Very Strong
8	Very, Very Strong
9	Extremely Strong
10	Strongest

Another common method for measuring workout intensity is Rate of Perceived Exertion (RPE). This method provides a scale in which an exerciser can subjectively determine how hard the exercise feels while working in a target training range. Descriptive words correspond with a 0 through 10 rating scale. The target range to exercise is between 4 and 6 on the rating scale. (This is a great method to use for those taking medications that effect one's heart rate and for those who want to fine tune how to be in touch with how their bodies respond to exercise). See the accompanying chart on this page.

3) **Time** - the duration of each exercise session.

The optimum duration of an exercise session depends on the intensity. Typically, an exercise session lasts for at least 20 to 30 minutes, although highly conditioned individuals often train continuously for an hour or longer. The duration of training is sometimes increased while intensity is decreased. This happens early in the training program to prepare the musculoskeletal system for vigorous exercise and to reduce the chance of injury.

REMEMBER: Use the F.I.T. principle as a guide to establish your program, however, make sure that you pay attention to how your body feels. Under-exercising may not be adequate for desired results. However, over-exercising can lead to injuries. Be sure to start slowly, and pace yourself.

The Cool Down

A gradual cool down helps prevent blood from pooling in your legs which may result in feeling light headed and dizzy. Active contraction by continuous movement of your legs and arms during the cool down helps pump blood back to your heart and brain. It is also important to stretch your muscles during the cool down. Use stretching exercises similar to those done during the warm up (see muscles listed in the warm up section). Stretching in this phase can be held for a longer period to help avoid muscle stiffness.

CLIMBING THE CONDITIONING LADDER - SUGGESTED PROGRAMS

The programs outlined below were developed by the director of services at the Lutheran General Hospital in Illinois. They were developed to help maintain or improve one's level of fitness, depending on the current fitness level. Follow each of the 6 week programs as they move in progression. Once Program V is achieved, continue at this same level of intensity for continued programs, however, add variety by changing around workouts per week, duration or add interval training (high intensity mixed with low intensity 70% - 90%). To add variety to intensity make, use of the incline feature on the Star Trac E Series Treadmill. This feature gives you an incline range from 0% to 15%.

Determining your Target Heart Rate Range

LOWER TARGET HEART RATE

$$\begin{aligned}
 & 220 \\
 - & \text{Your Age} \\
 = & \text{Estimated Max. Heart Rate} \\
 - & \text{Your Resting Heart Rate} \\
 = & \text{Value} \\
 \times & 60\% \\
 = & \text{Estimated Target} \\
 + & \text{Your Resting Heart Rate} \\
 = & \text{Target Heart Rate @ 60\%}
 \end{aligned}$$

UPPER TARGET HEART RATE

$$\begin{aligned}
 & 220 \\
 - & \text{Your Age} \\
 = & \text{Estimated Max. Heart Rate} \\
 - & \text{Your Resting Heart Rate} \\
 = & \text{Value} \\
 \times & 80\% \\
 = & \text{Estimated Target} \\
 + & \text{Your Resting Heart Rate} \\
 = & \text{Target Heart Rate @ 80\%}
 \end{aligned}$$

Lower Target Heart Rate

Upper Target Heart Rate

Program I:			
Week	Heart Rate (%)	Duration (minutes)	Workouts per Week
1,2	60 to 65	15	3
3,4	60 to 65	15	3
5,6	60 to 65	15	3
Program II:			
Week	Heart Rate (%)	Duration (minutes)	Workouts per Week
1,2	65 to 70	20	3
3,4	65 to 70	20	3
5,6	65 to 70	20	3
Program III:			
Week	Heart Rate (%)	Duration (minutes)	Workouts per Week
1,2	70 to 75	20	4
3,4	70 to 75	25	4
5,6	70 to 75	25	4
Program IV:			
Week	Heart Rate (%)	Duration (minutes)	Workouts per Week
1,2	75 to 80	25	4
3,4	75 to 80	25	4
5,6	75 to 80	30	4
Program V:			
Week	Heart Rate (%)	Duration (minutes)	Workouts per Week
1,2	80 to 85	30	4
3,4	80 to 85	35	4
5,6	80 to 85	35	4

PROGRAM VARIATION ON THE E SERIES TREADMILL

Everyone can benefit from using treadmills because walking, jogging, and running provide results. The Star Trac **E SERIES TREADMILL** gives you infinite workout possibilities. Here are some suggested programs for the deconditioned, average and athletic users.

Deconditioned (beginning) Exercisers

This group, which includes the overweight, cardiac rehabilitated and the senior population, requires more personal attention and one-on-one feedback for motivation rather than fancy programs built into the treadmill. Keeping everything simple is key. Before starting to exercise, becoming acquainted with basic treadmill features, including emergency stop button helps to make the exercise experience more fulfilling. The Quick Start program is a great place to start. The user, at all times has control of his/her workout, and all basic information feedback is provided. Another program recommended for this group is the Heart Training program. This program is great for learning how the heart rate responds to various levels of intensity. However, knowing one's target training range is necessary to operate this program. Starting speed for this group ranges from 2.0 to 3.0 mph. The incline shouldn't exceed 5% elevation unless instructed differently by a fitness professional. Progression of intensity and time is gradual (weekly) and frequency progress may not occur until after 4 weeks.

Average Exercisers

This group is classified by those who live somewhat active lifestyles (exercising about twice a week) or fit into the age category of 18-35. Confidence levels from this group are higher than the deconditioned group, therefore the willingness to try new or more advanced programs is greater. While most tend to enter immediately into a quick start, encouraging use of other programs may keep participation consistent and workouts more alive. The Alpine Pass offer great variations that make good use of incline, making a running or walking workout more interesting and challenging. The heart rate programs are a good way to monitor and challenge intensity ranges, which is great for achieving results in a cardiovascular endurance program.

Starting speed for this group ranges from about 3.0 to 3.5 mph. Typically, exercisers in this category will not use elevation, however, it is strongly encouraged for varied intensity and variability. Exercisers in this category may not be comfortable exceeding 10% incline. Progression of intensity and time is gradual (weekly) and frequency progress may not occur until after 4 weeks.

Athletic Exercisers

The Manual program is ideal for speed training, or anaerobic training. If competition is an interest, the 5K run offers the user a route to

follow and a means to monitor progress. While many of the programs include a warm-up phase, in the Manual Program make sure a warm-up and cool-down period is factored in. If you are doing a running workout, a good starting speed is 5.0 mph. If you are doing a walking or jogging workout, a good starting speed is 3.8 mph.

Target Training Chart

Use the following table for a quick glance at your target training zone for both heart rate and rate of perceived exertion.

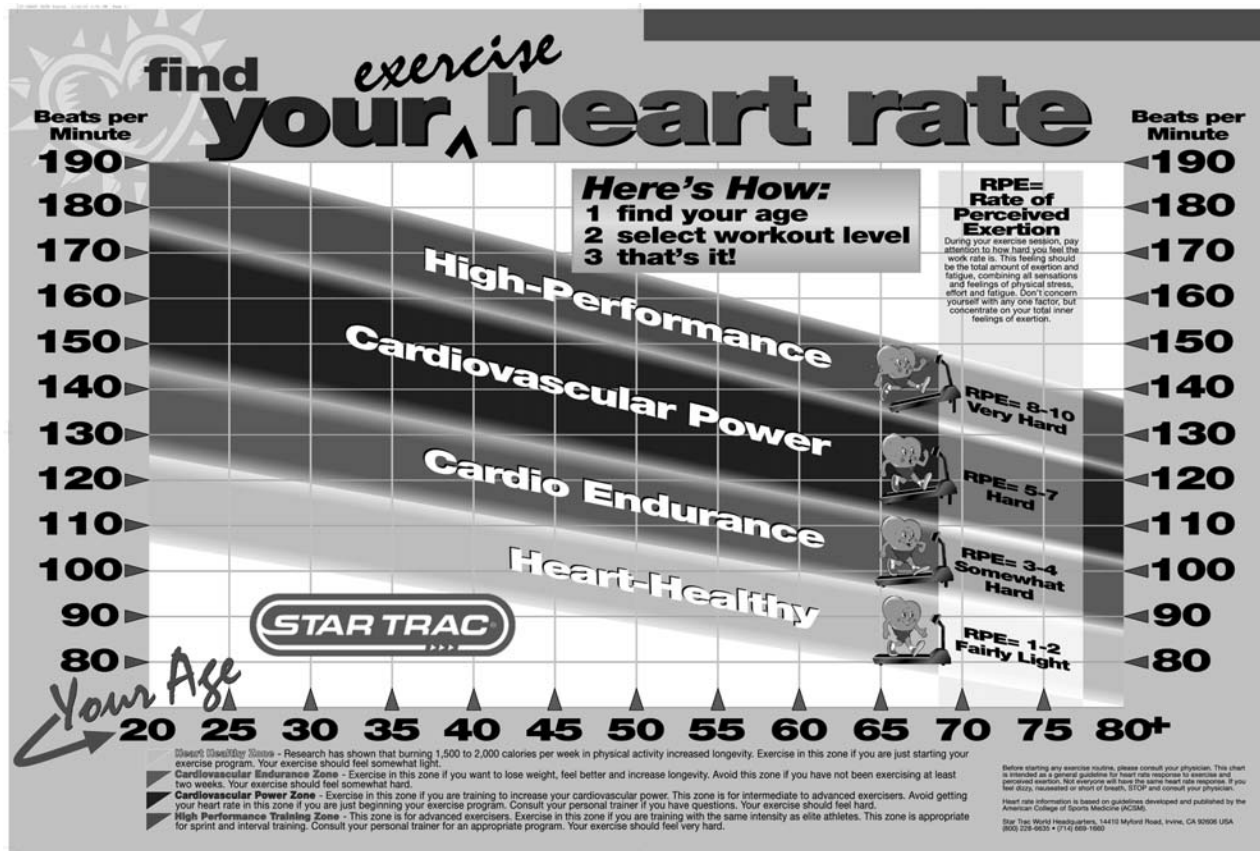

TIPS TO STAY MOTIVATED

Set Goals and Reward yourself: Determine precisely what you want to achieve. By setting challenging, specific goals, you are setting yourself up to achieve them. When you achieve those goals, reward yourself. "It's crucial (to reward yourself)," according to Lauve Metcalfe, Director of Program Development at the Campbell Institute for Health and Fitness in Camden, New Jersey. "Who quits a program because he's having too much fun?" Example of tangible rewards: A new pair of running shoes if you knock a minute off your time in the mile.

Schedule your workout: Get into the habit of working out at the same time each day. And, write that time on your calendar. Make keeping your workout schedule as important as eating or sleeping.

Watch your progress: Follow your movement on the Graphic Display to help pass time and cut down on boredom.

Plan an active vacation: If you know you're going on a walking tour of Paris or on a mountain hiking trip next summer, you'll look forward to getting into shape for it.

Exercise in numbers: Get a workout partner or exercise in a group. This will offer you support and a level of accountability, (not to let your partner or group down for not showing up).

Train for a race or enter an event: A race is a great goal toward which to work, and the excitement of competition is sure to keep you going. Try a 5K run.

Avoid too much too soon: Stress and discomfort of an over-aggressive program can be overwhelming and lead to injuries.

Vary your workouts: Once accustomed to a program, vary the workout so that your routine doesn't become mundane. It's also important to recruit new muscle fibers to a new exercise to keep the body stimulated to make improvements.

Star Trac strongly recommends performing regular preventive maintenance on your **STAR TRAC E SERIES TREADMILL**. Without regularly scheduled maintenance, normal wear and tear may cause cumulative effects, such as misalignment or premature wear. This may result in downtime. For this reason, we highly recommend following the maintenance schedules. Additionally, unusual symptoms, such as display codes and blown circuit breakers, should be reported to **STAR TRAC PRODUCT SUPPORT DEPARTMENT** at (800) 503-1221, or USA 1-714-669-1660. If any components are found to be worn or damaged, the treadmill should be removed from service until repairs can be made. Only components supplied or approved by Star Trac shall be used to maintain and/or repair the treadmill.

DAILY MAINTENANCE

- Remove excessive accumulations of dust, dirt, and other substances by using a clean soft cloth and a non-abrasive liquid cleaner, such as Formula 409™ or FANTASTIK™. Wipe down the display board, handrails, shroud and heart rate grips.

NOTE: DO NOT spray the cleaner directly onto the display board or heart rate grips. Do not use liquid cleaner under the running belt.

- To ensure the longevity of the running belt, clean under the running belt with a soft, dry cloth. To clean, slide the cloth between the running belt and deck from one side of the frame to the other (you may need a ruler or similar tool to slide the towel under the belt), then, holding the edges of the cloth, pull the cloth from the headroller down to the tailroller.

NOTE: DO NOT clean the running belt by activating the treadmill.

- Inspect the running belt for alignment and tension. Do not tighten the running belt every day. If you notice slipping, adjust the running belt tension using the instructions provided in “Adjustments-Slipping-Running Belt” (later in this chapter), or contact Product Support as described at the beginning of this chapter.
- Ensure the power cord is not under the treadmill and is positioned away from the elevation screws. This will prevent the power cord from being pinched or from binding up the elevation screws.

WEEKLY MAINTENANCE

- Vacuum the floor under and around the treadmill. Do so with the treadmill at its maximum elevation or moved to another spot.

NOTE: Take care not to damage the power cord while vacuuming.

- Inspect the inside surface of the running belt and the top surface of the running deck for unusual wear. Check the belt for a “glazed” condition (a smooth almost melted appearance). If the running belt appears glazed, replace the running belt and flip or replace the running deck.

NOTE: Never install a new running belt on a used deck.

- Inspect the display and handrail screws for security, and retighten if necessary.
- Inspect the display panel/keypad for wear.

BI-WEEKLY MAINTENANCE

WARNING: To prevent personal injury, always turn the treadmill off and unplug the power cord before performing maintenance inside the motor compartment.

- Remove the motor shroud and vacuum around the motor and its ventilation holes. Avoid bumping or damaging parts normally protected by the shroud.

MONTHLY MAINTENANCE

- Wipe the elevation screws down with a clean dry cloth and coat them with silicon lubricant spray to prevent rust accumulation.

ADJUSTMENTS

The running belt and its headroller, drive belt, tailroller, and running deck are designed to be self-centering, slip-free, and smooth-operating without the need for frequent adjustments. Running belt sideward movement, slipping, or grinding after extended use, or thumping during initial use, may be corrected by the following procedures:

Change Sideward Movement to TRACKING: If the running belt is not centered on the tailroller and is either too far left or right, adjust tracking using the following steps:

1. Turn the treadmill on. Increase treadmill speed to 3.0 mph (5.0 kph).
2. Adjust tracking by adjusting the tailroller Allen screws (located at the back sides of the tailroller) with a 1/4" Allen wrench in 1/4-turn increments.

If the running belt is tracking to the left, adjust the running belt to track to the right. Tighten the left tailroller Allen screw by turning clockwise, or loosen the right tailroller bolt by turning counter-clockwise.

If the running belt is tracking to the right, adjust the running belt to track to the left. Tighten the right tailroller Allen screw by turning clockwise or loosen the left tailroller bolt by turning counter-clockwise.

3. After the running belt appears to be tracking properly, increase the treadmill speed to 10.0 mph (16.0 kph) and verify that the belt stays centered.

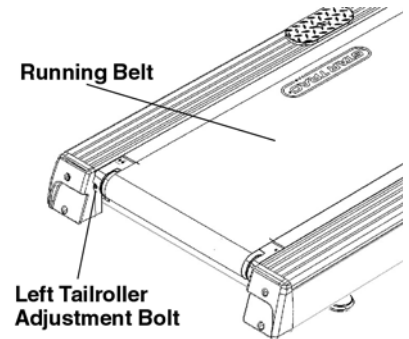

Slipping-Running Belt: Remove the motor shroud and operate the treadmill slowly at 1 to 2 mph (2 to 3 kph). While observing the headroller, walk on the belt and try to slow it down by gently applying pressure with your feet while holding the handrails. If only the running belt, and not the headroller, slows down, tighten the running belt by turning both the right and left tailroller adjustment bolts clockwise 1/4-turn. Repeat this adjustment until the running belt no longer slips, ensuring that you turn both tailroller bolts an equal number of turns. Re-install the motor shroud. If the headroller and the running belt both slow down, tighten the drive belt as described under "Slipping-Drive Belt", below.

Slipping-Drive Belt: Adjust the treadmill incline to 5% to provide clearance underneath. Set the ON/OFF switch to the OFF position and unplug the treadmill. Remove the motor shroud. With a 1/2" socket wrench, loosen the four motor bolts. Use the socket wrench to adjust the tension bolt in the middle of the motor bracket 1/4-turn clockwise, stretching the drive belt. Tighten the motor bolts and re-install the motor shroud. Plug the treadmill in, turn it on, and test for slipping as described under "Slipping-Running Belt", above. Repeat this step as necessary.

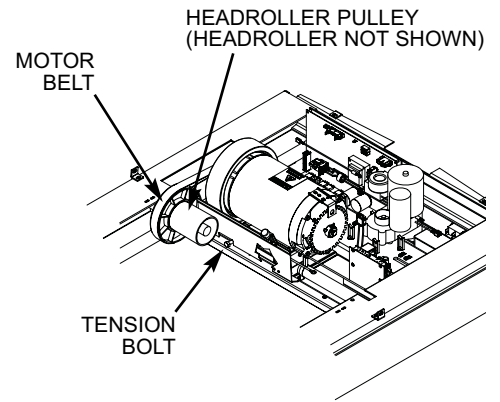

Thumping: Turn the treadmill off. Turn the right and left tailroller adjustment bolts counter-clockwise with the 1/4" Allen wrench until the running belt is loose. Note the number of times each bolt is turned. Remove excess accumulated running built up from the tailroller with a credit card, a putty knife, or other flexible plastic implement. Tighten the running belt by turning the adjustment bolts clockwise the same number of turns as they were loosened. Turn the treadmill on and check for sideward movement and/or slipping of the running belt. Tighten the tailroller adjustment bolts further, if necessary, in 1/4-turn increments.

WAX BELT

CAUTION: Do not wax the belt on your E-Series Treadmill, as this model is equipped with a waxless belt and deck system.



TOOLS & MATERIALS

- Clean Towel (1)
- Paint Stick or Ruler (1)
- Diluted All-purpose Cleaner (409), or Bristle Brush

After having used your **STAR TRAC E SERIES TREADMILL** for many workouts, you may wish to change some of its settings.

MANAGER MODE

The Manager Mode allows you to query and modify the basic settings of your treadmill. To enter Manager Mode:

1. Press and *hold* the , , and  keys together.
2. A beep will sound and “MANAGER MODE” will display momentarily in the Information Window.
3. Release the keys. “MCI VX.XX CKSM XXXX” will display in the Information Window.

NOTE: The system will automatically exit Manager Mode if no key is pressed for 30 seconds.

The following keys are available in MANAGER MODE:



Incline Keys: Displays the next  and previous  parameter, respectively. Keys will repeat if held.



Speed Keys: Adjust the value of the displayed parameter up and down, respectively, in increments of 1 unit or 0.01 unit, as appropriate for the parameter. These keys *do not* save the new value - see  **Key** below.



OK Key: Updates (saves) the value of the displayed parameter in Flash memory. Alternatively, the START key may be used (see above).



Number/Program Select Keys: Enter new data item values for numeric parameters.



Stop Key: Exits Manager Mode and restarts the treadmill greeting.

The items that you may display and change with the previous keys are:



Item	Lowest Value	Default Value	Highest Value	Meaning
MC1 V X.XX	N/A	N/A	N/A	Display's primary processor software version and checksum.
MC2 V X.XX	N/A	N/A	N/A	Display's secondary processor software version and checksum.
SERIAL NO	0	0	65,535	Treadmill serial number.
UNITS	-	English	-	English = units of pounds, miles, hours, minutes, seconds, feet, inches; Metric = units of kilograms, kilometers, hours, minutes, seconds, centimeters.
TIME	5	99	99	Maximum time in minutes allowed for program, including warm-up.
WEIGHT	1	155/70	500/226	Default (to user), typical weight in lb (UNITS=English), or kg (UNITS=Metric).
LANGUAGE	-	English	-	Language in English, Dutch, French, German, Portuguese, Spanish, Swedish, Italian or Katakana.
METS	OFF	OFF	ON	ON=METS display enabled. OFF=METS display disabled.
PAUSE	30	45	120	Pause duration during a program, in seconds, either 30, 45, 60, 90 or 120.
AUTO FAN	OFF	ON	ON	Turns ON the fan 1 minute into the program.
ELEVATION	OFF	ON	ON	ON=Elevation function enabled. OFF=Elevation function disabled.

Item	Lowest Value	Default Value	Highest Value	Meaning
AUTO STOP	OFF	OFF	ON	ON=Auto stop feature enabled. OFF=Auto stop feature disabled.
CSAFE	OFF	OFF	ON	ON=CSAFE communication enabled. OFF=CSAFE communication disabled.
LOCK OUT	OFF	OFF	ON	ON=Treadmill lock out enabled. OFF=Treadmill lock out disabled.
LOCKOUT ID	10000	12345	65535	Treadmill lockout ID.
MINIMUM SPEED*	0.5/0.8	0.5/0.8	2.0/3.2	Minimum speed in mph (UNITS=English), or km/hr (UNITS=Metric).
MAXIMUM SPEED*	5.0/5.0	10.0/16.0	12.5/20.0	Maximum speed in mph (UNITS=English), or km/hr (UNITS=Metric). Caution: See Motor Calibration before making any changes.
ACCELERATION TIME	25	25	60	Time, in seconds, to reach maximum speed from 0 mph (0 km/hr).
DECELERATION TIME	20	20	60	Time, in seconds, to reach 0 mph (0 km/hr) from maximum speed.

*When the MINIMUM SPEED or MAXIMUM SPEED parameters are changed, the Treadmill will perform an auto calibration. To terminate the auto calibration and return the parameter to its default setting, press the STOP key.

MAINTENANCE MODE

Your Service Representative may need to check accumulated data about the past usage of your treadmill, test its motor and display controls, or investigate error messages. For these reasons, your treadmill is equipped with Maintenance Mode. Maintenance Mode includes all of the items available through Manager Mode, plus additional items for Service and Diagnostic use. To enter Maintenance Mode:

1. Press and *hold* the , , and  keys together.
2. A beep will sound and "MAINTENANCE MODE" will display momentarily in the Information Window.
3. Release the remaining keys. "MCI VX.XX CKSM XXXX" will display in the Information Window.

The following keys are available in MAINTENANCE MODE:



Incline Keys: Displays the next and previous parameter, respectively. Keys will repeat if held.



Speed Keys: Adjust the value of the displayed parameter up and down, respectively, in increments of 1 unit or 0.01 unit, as appropriate for the parameter. These keys *do not* save the new value - see **Start Key** and  **Key** below.



Enter Key: Updates (saves) the value of the displayed parameter in Flash memory. Alternatively, the  key may be used (see above).



Number/Program Select Keys: Enter new data item values for numeric parameters.



Stop Key: Exits Maintenance Settings Mode and restarts the treadmill greeting.

The items that you may display and change with the previous keys are:





Item	Lowest Value	Default Value	Highest Value	Meaning
MC1 V X.XX	N/A	N/A	N/A	Display's primary processor software version and checksum.
MC2 V X.XX	N/A	N/A	N/A	Display's secondary processor software version and checksum.
SERIAL NO	0	0	65,535	Treadmill serial number.
OPER HOURS	0	0	65,535	Total operating hours.
DISTANCE	0	0	65,535	Total treadmill miles (UNITS=English), or km (UNITS=Metric).
UNITS	-	English	-	English = units of pounds, miles, hours, minutes, seconds, feet, inches; Metric = units of kilograms, kilometers, hours, minutes, seconds, centimeters.
TIME	5	99	99	Maximum time in minutes allowed for program, including warm-up.
WEIGHT	0	155/70	500/226	Default (to user), typical weight in lb (UNITS=English), or kg (UNITS=Metric).
LANGUAGE	-	English	-	Language in English, Dutch, French, German, Portuguese, Spanish, Swedish, Italian or Katakana.
METS	-	OFF	-	ON=METS display enabled. OFF=METS display disabled.
PAUSE	30	45	120	Pause duration during a program, in seconds, either 30, 45, 60, 90 or 120.
AUTO FAN	-	OFF	-	Turns on the fan 1 minute into program.
ELEVATION	-	ON	-	ON=Elevation function enabled. OFF=Elevation function disabled.
AUTO STOP	-	OFF	-	ON=Auto stop feature enabled. OFF=Auto stop feature disabled.
CSAFE	-	OFF	-	ON=CSAFE communication enabled. OFF=CSAFE communication disabled.
PVS	-	ATSC	-	PVS type, ATSC/NTSC OR PAL/SECAM.
LOCK OUT	-	OFF	-	ON=Treadmill lock out enabled. OFF=Treadmill lock out disabled.
LOCKOUT ID	10000	12345	65535	Treadmill lockout ID.
MINIMUM SPEED	0.5/0.8	0.5/0.8	2.0/3.2	Minimum speed in mph (UNITS=English), or km/hr (UNITS=Metric).
MAXIMUM SPEED	5.0/5.0	10.0/16.0	12.5/20.0	Maximum speed in mph (UNITS=English), or km/hr (UNITS=Metric). Caution: See Motor Calibration before making any changes.
ACCELERATION TIME	25	25	60	Time, in seconds, to reach maximum speed from 0 mph (0 km/hr).
DECELERATION TIME	20	20	60	Time, in seconds, to reach 0 mph (0 km/hr) from maximum speed.
MODEL	-	E-SERIES	-	Treadmill Model

Item	Lowest Value	Default Value	Highest Value	Meaning
DATE	1.00	1.98	12.99	Treadmill manufacture date.
STOP SWITCH	-	-	-	Either E-Stop or Lanyard.
LAST DECK	0	0	65,535	Number of miles (UNITS=English), or km (UNITS=Metric) since the running deck was last serviced or replaced.
LAST BELT	0	0	65,535	Number of miles (UNITS=English) or km (UNITS=Metric) since the running belt was last replaced.
PROGRAM STATS	-	-	-	Provides access to programs usages and counters. (See Sub Menu)
LED TEST	-	-	-	LED Testing function, Press OK to begin
KEYPAD TEST	-	-	-	LED Testing function, Press OK to begin.
HEART RATE TEST	-	-	-	HEART RATE Test function.
SERIAL PORTS TEST	-	-	-	RS 232 Ports test (Manufacture Test Only).
ERROR STATS	-	-	-	Provides Access to Error List.
LAST ERROR LIST	-	-	-	Last Error List Menu, Press OK to View
CALIBRATION VALUES	-	-	-	Provides Access to View Calibration Data.
MOTOR CALIBRATION	-	-	-	Motor Calibration Function, Press OK to begin.
ELEV CALIBRATION	-	-	-	Elevation Calibration Function, Press OK to begin.
BURN IN MODE	-	-	-	Burn In Mode Function (Manufacture Only).

*When the MINIMUM SPEED or MAXIMUM SPEED parameters are changed, the Treadmill will perform an auto calibration. To terminate the auto calibration and return the parameter to its default setting, press the STOP key.







MOTOR CALIBRATION

The Motor Calibration function allows for calibration of the treadmill's speed function. CAUTION: Changing Max Speed setting may expose users to increase risk. Any changes to the treadmills maximum speed settings should be clearly communicated to all users of the treadmill. To enter the Motor Calibration function:

1. While in the Maintenance Mode, press the  key, or navigate to the Motor Calibration by the next  or the previous  parameter buttons .
2. While in the Motor Calibration, press the  key to begin the calibration. The information window will display "PWM= XXXXXX SPEED=XX.X" where the X's are data the that test will generate.
When the test is finished the information window will display one of the 2 messages "Passed Calibration" or "Failed Calibration". If "Failed Calibration" is displayed run test again, if it continues, call for maintenance.
3. Press the STOP key to exit the Motor Calibration function.

ELEVATION CALIBRATION

The Elevation Calibration function allows for calibration of the treadmill's elevation function. To enter the Elevation Calibration function:

1. While in the Maintenance Mode, navigate to the Elevation Calibration by the next  or the previous  parameter buttons. Press the  key, the Information Window will display the message "USE INCLINE +/- TO MOVE ELEVATION".
2. Press the  key, as necessary, until the treadmill is at its lowest elevation. When desired minimum elevation is obtained, press the  key.
3. Next press the  key, as necessary, until the treadmill is at its highest elevation. When desired maximum elevation is obtained, press the  key.
8. Press the STOP key to exit the Elevation Calibration function.

Star Trac recommends that you refer your questions about your **STAR TRAC E SERIES TREADMILL** operation and suspected malfunctions to Star Trac's Service Hotline at (800) 503-1221, or USA 1-714-669-1660. However, you may wish to investigate error messages that appear in the Information Window. You may do so by reviewing the information in this section.

KEY DOWN: This error generally occurs when a key is held pressed while the **ON/OFF** switch is moved to **ON**. It may also happen if a key becomes stuck. When you see **KEY DOWN**:

- Set the **ON/OFF** switch to **OFF**; wait 2 seconds.
- Set the **ON/OFF** switch to **ON**. The treadmill should be operational again. Notify Star Trac if additional assistance is needed.

NO STOP: This error generally occurs when the Stop Switch is not connected tightly to the circuit board of the Display Control Panel. It may also happen if the circuitry associated with the switch develops a fault. When you see **NO STOP**:

- Set the **ON/OFF** switch to **OFF**; wait 2 seconds.
- Set the **ON/OFF** switch to **ON**. Notify Star Trac if additional assistance is needed.

CHECK SPEED SYS and SPEED CHANGE: These errors generally occur when the running belt speed sensor is disconnected, faulty, or misaligned relative to the revolutions-per-minute (RPM) sensor of the motor. They may also occur if the speed sensor cable is damaged, or if the Motor Control Board (MCB) is misadjusted or faulty. When you see **CHECK SPEED SYS** or **SPEED CHANGE**:

- Set the **ON/OFF** switch to **OFF**; wait 2 seconds.
- Set the **ON/OFF** switch to **ON**. Notify Star Trac if additional assistance is needed.

ELEV STALL, ELEV RANGE and ELEV LOST: These errors generally occur when the elevation (incline) potentiometer is faulty or out of limits, or the elevation motor is disconnected or receiving low power. They may also occur if the Motor Control Board (MCB) is faulty or the motor gears are stripped. They are usually accompanied by failure of the treadmill to rise from an elevation other than maximum (or descend from an elevation other than minimum), with attendant beep indication.

FCC AND OTHER DOMESTIC / INTERNATIONAL REGULATIONS

The **E SERIES TREADMILLS** have been tested and found to comply with the limits for a Class A digital device, pursuant to Part 15 of FCC rules. Under the FCC guidelines, operation is subject to the following two guidelines: (1) this device may not cause harmful interference, and (2) this device must accept any interference received, including interference that may cause undesired operation.

The Star Trac **E SERIES TREADMILLS** generate and use radio frequency energy. If the products are not installed and used in accordance with the instructions provided in the owner's manual, interference with radio communications may occur. Likewise, if unapproved accessories are installed, interference with radio communications may occur. The intent of the FCC Class A limit is to provide reasonable protection against harmful interference in a residential installation. However, there is no guarantee that interference may not occur in a specific installation. In the event that interference is experienced, turn off the unit to verify that it is in fact the source. If the interference clears with the unit off, then try each of the following measures and combinations thereof:

- Reorient or relocate the treadmill.
- Reorient or relocate the receiving antenna of your television, radio, and / or VCR recorder.
- Connect the unit to a different power outlet.
- Consult Star Trac Product Support, your authorized dealer, or a qualified radio / television technician for assistance.

This product has been tested to meet the following standards:

- UL 1647 (Safety for Motor operated Message and Exercise Machines).
- CAN/CSA – E335-1/3E -94- Safety of household and Similar appliance

INTERNATIONAL REGULATIONS

This product conforms to the requirements of the European Council directives:

- 89/336/ECC, Electromagnetic Compatibility
- 92/590/EEC, General Product Safety Directives
- 73/23/EEC, Electrical equipment Low Voltage Safety Directive

Under the Directive and in addition to Domestic standards, the product also has been tested to meet the following international standards:

EN 60355-1	Safety of the household and Similar Electrical appliance
EN957-1	Safety of Machinery
EN55022	Conducted and Radiated Emission Class A
EN55014-1	Disturbance power
EN55014-2	Immunity
EN60947-5-1	Positive opening mechanism :VDE approval (pending)
EN61000-3-2	Harmonics Current Emission
EN61000-3-3	Flicker and Voltage Fluctuation
EN61000-4-3	Radiated Immunity/ Conducted Immunity
EN61000-4-2	ESD
EN61000-4-4	EFT
EN61000-4-5	Surge
EN61000-4-11	Voltage Dip & Interruption



expect different.

STAR TRAC

14410 Myford Road

Irvine, California 92606

Telephone: (800) 228-6635, (714) 669-1660

Fax: (714) 508-3303

<http://www.startrac.com>